

SL Paper 2

A beam of coherent monochromatic light from a distant galaxy is used in an optics experiment on Earth.

The beam is incident normally on a double slit. The distance between the slits is 0.300 mm. A screen is at a distance D from the slits. The diffraction angle θ is labelled.

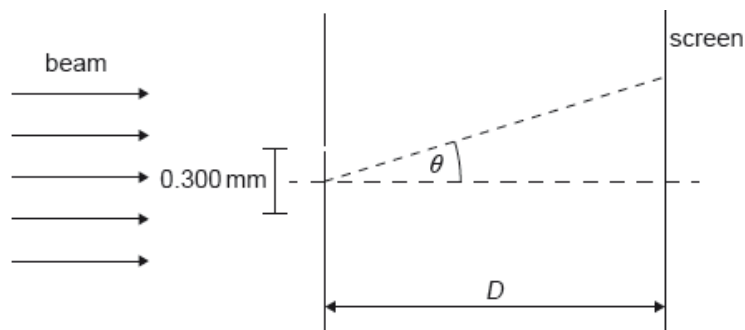

The air between the slits and the screen is replaced with water. The refractive index of water is 1.33.

a.i. A series of dark and bright fringes appears on the screen. Explain how a dark fringe is formed. [3]

a.ii. The wavelength of the beam as observed on Earth is 633.0 nm. The separation between a dark and a bright fringe on the screen is 4.50 mm. [2]

Calculate D .

b.i. Calculate the wavelength of the light in water. [1]

b.ii. State **two** ways in which the intensity pattern on the screen changes. [2]

Markscheme

a.i. superposition of light from each slit / interference of light from both slits

with path/phase difference of any half-odd multiple of wavelength/any odd multiple of π (in words or symbols)

producing destructive interference

Ignore any reference to crests and troughs.

[3 marks]

a.ii. evidence of solving for D « $D = \frac{sd}{\lambda}$ »

$$\left\langle \frac{4.50 \times 10^{-3} \times 0.300 \times 10^{-3}}{633.0 \times 10^{-9}} \times 2 \right\rangle = 4.27 \text{ «m»}$$

Award **[1]** max for 2.13 m.

[2 marks]

b.i. $\frac{633.0}{1.33} = 476 \text{ «nm»}$

[1 mark]

b.ii. distance between peaks decreases

intensity decreases

[2 marks]

Examiners report

a.i. [N/A]

a.ii. [N/A]

b.i. [N/A]

b.ii. [N/A]

This question is in **two** parts. **Part 1** is about a simple pendulum. **Part 2** is about the Rutherford model of the atom.

Part 1 Simple pendulum

A pendulum consists of a bob suspended by a light inextensible string from a rigid support. The pendulum bob is moved to one side and then released. The sketch graph shows how the displacement of the pendulum bob undergoing simple harmonic motion varies with time over one time period.

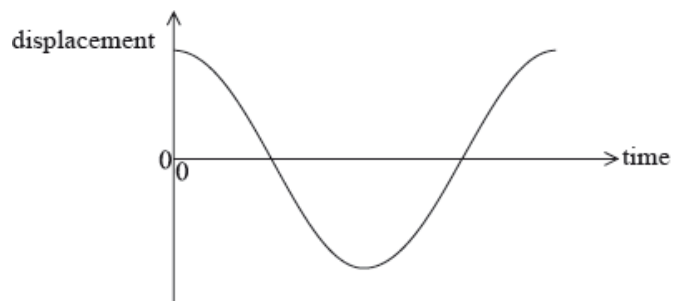

On the sketch graph above,

A pendulum bob is moved to one side until its centre is 25 mm above its rest position and then released.

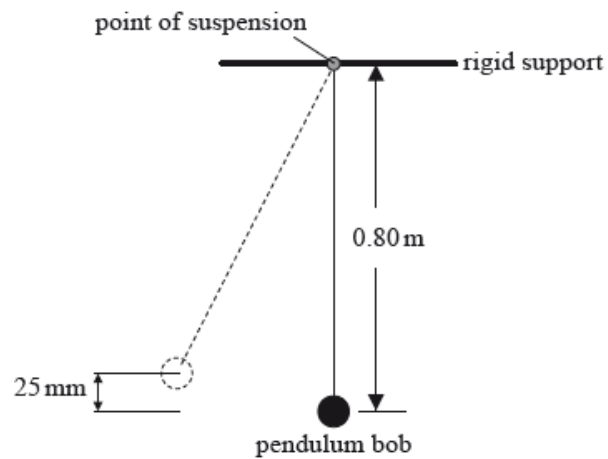

The point of suspension of a pendulum bob is moved from side to side with a small amplitude and at a variable driving frequency f .

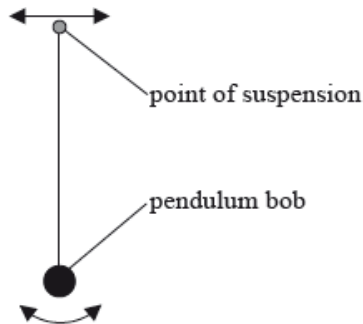

For each value of the driving frequency a steady constant amplitude A is reached. The oscillations of the pendulum bob are lightly damped.

Part 2 Rutherford model of the atom

The isotope gold-197 ($^{197}_{79}\text{Au}$) is stable but the isotope gold-199 ($^{199}_{79}\text{Au}$) is not.

Part (i). a. label with the letter A a point at which the acceleration of the pendulum bob is a maximum. [2]

(ii) label with the letter V a point at which the speed of the pendulum bob is a maximum.

Part (ii). Explain why the magnitude of the tension in the string at the midpoint of the oscillation is greater than the weight of the pendulum bob. [3]

Part (ii). c. Show that the speed of the pendulum bob at the midpoint of the oscillation is 0.70 m s^{-1} . [5]

(ii) The mass of the pendulum bob is 0.057 kg . The centre of the pendulum bob is 0.80 m below the support. Calculate the magnitude of the tension in the string when the pendulum bob is vertically below the point of suspension.

Part (ii). d. On the axes below, sketch a graph to show the variation of A with f . [4]

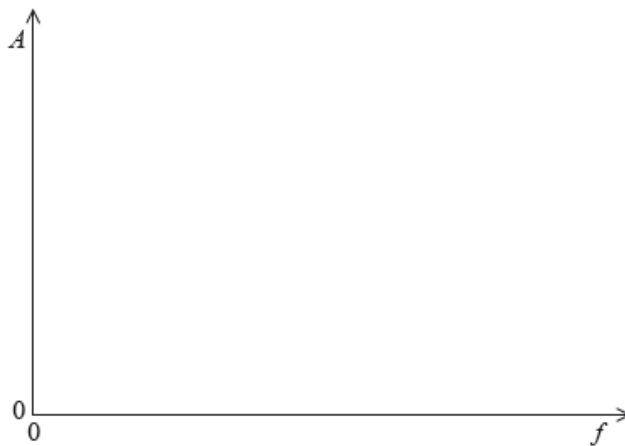

(ii) Explain, with reference to the graph in (d)(i), what is meant by resonance. [2]

The pendulum bob is now immersed in water and the variable frequency driving force in (d) is again applied. Suggest the effect this immersion of the pendulum bob will have on the shape of your graph in (d)(i). [2]

Most alpha particles used to bombard a thin gold foil pass through the foil without a significant change in direction. A few alpha particles are deviated from their original direction through angles greater than 90° . Use these observations to describe the Rutherford atomic model. [5]

Outline, in terms of the forces acting between nucleons, why, for large stable nuclei such as gold-197, the number of neutrons exceeds the number of protons. [4]

(ii) A nucleus of $^{199}_{79}\text{Au}$ decays to a nucleus of $^{199}_{80}\text{Hg}$ with the emission of an electron and another particle. State the name of this other particle.

Markscheme

Part (i) a. one A correctly shown;

(ii) one V correctly shown;

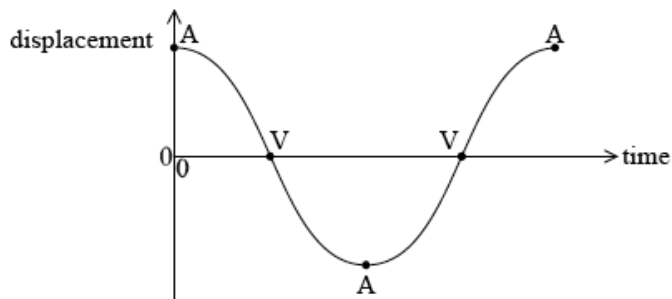

Part (i) b. pendulum bob accelerates towards centre of circular path / OWTTE;

therefore force upwards;

that adds to tension produced by the weight;

Part (i) c. evidence shown of equating kinetic energy and gravitational potential energy;

$$v = \sqrt{(2 \times 9.8 \times 0.025)};$$

$$= 0.70 \text{ m s}^{-1}$$

Allow $g = 10 \text{ m s}^{-2}$ answer 0.71 m s^{-2} .

(ii) centripetal acceleration $\left(= \frac{v^2}{r} \right) \left[= \frac{0.7^2}{0.8} \right] = 0.61 \text{ (m s}^{-2}\text{)};$

net acceleration = $(9.81 + 0.61 =) 10.4 \text{ (ms}^{-2}\text{)}$ or $T - mg = m \times 0.61$;

tension = $(ma =) 0.59 \text{ N}$;

Allow $g = 10 \text{ m s}^{-2}$ answer 0.60 N .

Award **[3]** for bald correct answer.

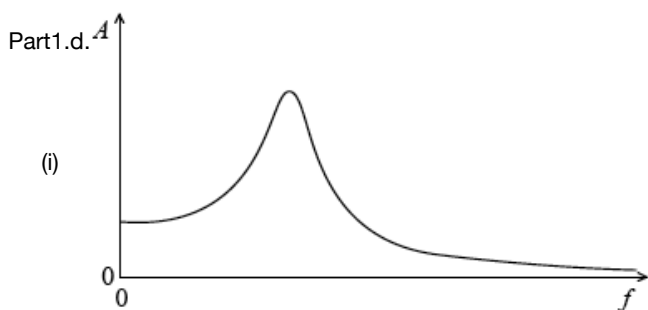

one maximum shown and curve broadly similar to example above;

amplitude falls on each side by lower amount on low driving frequency side;

(ii) resonance is where driving frequency equals/close to natural frequency;

the frequency at the maximum amplitude of the graph;

Part 1.e.

with a much broader resonance peak;

maximum moves to left on graph;

Award **[2]** for a sketch graph.

Part 2.a.

most of the mass/(protonic) charge of the atom is concentrated in the nucleus/nucleus is dense;

nucleus is positively charged; { *These points can*
(most) alphas not close enough to nuclei to be deflected; *be awarded to a*
(very few) alphas (are) close enough to nuclei to be deflected; *labelled diagram.*

To award the last two marking points for a diagram response the candidate must show that a non-deflected alpha is well away from a nucleus and a strongly deflected alpha is aimed very close or head-on.

Part 2.b.

mention of strong (nuclear) force (between nucleons);

overall balance must be correct (and more neutrons needed for this);

Award **[0]** for a statement that neutron is negative.

(ii) anti neutrino / $\bar{\nu}$;

Examiners report

Part 1.a.

Part 1.b.

Part 1.c.

Part 1.d.

(ii) Candidates who kept a clear head were able to arrive at a correct answer even if they had failed in part (b)

Part 1. d. Graphs were poor in general with few gaining both marks and many candidates unable to make any progress. Graphs often showed a decreasing amplitude against time despite the frequency label on the x -axis.

(ii) Few understood the meaning of the term “resonance” sufficiently to be able to describe it in terms of the graph.

Part 1. e. Again, few candidates referred their answer to the graph. Some were able to gain credit for discussing changes in amplitude.

Part 2. a. Candidates who rely on a diagram rather than a written description must ensure that their sketches give all the required information unambiguously.

In this type of question it is also common to see candidates repeating part of the question itself back to the examiner; this will not gain credit.

Candidates needed to distinguish between those alpha particles passing close to and those far away from a nucleus, and then to give the deduced properties of the nucleus from these observations. Descriptions were often illogical and repetitive.

Part 2. b. Most candidates could write with confidence about the repulsive nature of the proton-proton interaction and the attractive nature of the strong nuclear force. Few gave good accounts of the balance between these two forces or described the energy situation (a better way to answer). Weak candidates could not name the strong nuclear force adequately.

This question is in **two** parts. **Part 1** is about the oscillation of a mass. **Part 2** is about nuclear fission.

Part 1 Oscillation of a mass

A mass of 0.80 kg rests on a frictionless surface and is connected to two identical springs both of which are fixed at their other ends. A force of 0.030 N is required to extend or compress each spring by 1.0 mm. When the mass is at rest in the centre of the arrangement, the springs are not extended.

The mass is displaced to the right by 60 mm and released.

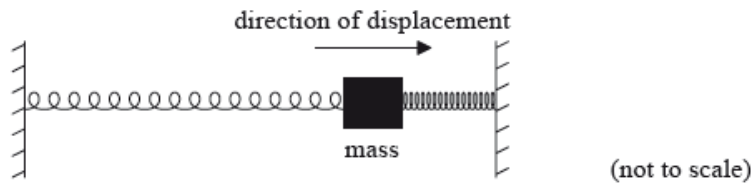

The motion of an ion in a crystal lattice can be modelled using the mass–spring arrangement. The inter-atomic forces may be modelled as forces due to springs as in the arrangement shown.

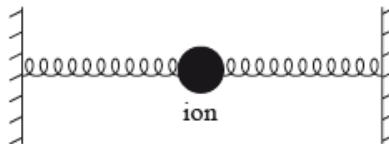

The frequency of vibration of a particular ion is 7×10^{12} Hz and the mass of the ion is 5×10^{-26} kg. The amplitude of vibration of the ion is 1×10^{-11} m.

Part 2 Nuclear fission

A reaction that takes place in the core of a particular nuclear reactor is as shown.

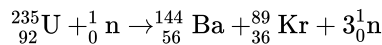

In the nuclear reactor, 9.5×10^{19} fissions take place every second. Each fission gives rise to 200 MeV of energy that is available for conversion to electrical energy. The overall efficiency of the nuclear power station is 32%.

In addition to the U-235, the nuclear reactor contains a moderator and control rods. Explain the function of the

a.i. Determine the acceleration of the mass at the moment of release. [3]

a.ii. Outline why the mass subsequently performs simple harmonic motion (SHM). [2]

a.iii. Calculate the period of oscillation of the mass. [2]

b.i. Estimate the maximum kinetic energy of the ion. [2]

b.ii. On the axes, draw a graph to show the variation with time of the kinetic energy of mass and the elastic potential energy stored in the springs. [3]

You should add appropriate values to the axes, showing the variation over one period.

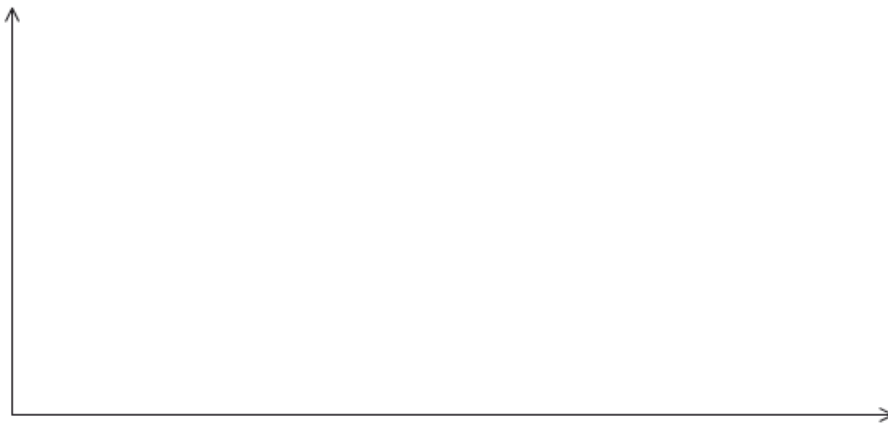

c.i. Calculate the wavelength of an infrared wave with a frequency equal to that of the model in (b). [1]

d.i. Determine the mass of U-235 that undergoes fission in the reactor every day. [3]

d.ii. Calculate the power output of the nuclear power station. [2]

e.i. moderator. [3]

e.ii. control rods. [2]

Markscheme

a.i. force of 1.8 N for each spring so total force is 3.6 N;

$$\text{acceleration} = \frac{3.6}{0.8} = 4.5 \text{ ms}^{-2}; \text{ (allow ECF from first marking point)}$$

to left/towards equilibrium position / negative sign seen in answer;

a.ii. force/acceleration is in opposite direction to displacement/towards equilibrium position;

and is proportional to displacement;

$$\text{a.iii. } \omega = \left(\sqrt{\frac{a}{x}} \right) = \sqrt{\frac{4.5}{60 \times 10^{-3}}} (= 8.66 \text{ rad s}^{-1});$$

$$T = 0.73 \text{ s};$$

Watch out for ECF from (a)(i) eg award [2] for $T = 1.0 \text{ s}$ for $a = 2.25 \text{ m s}^{-2}$.

$$\text{b.i. } \omega = 2\pi \times 7 \times 10^{12} (= 4.4 \times 10^{13} \text{ Hz});$$

$$5 \times 10^{-21} \text{ J};$$

Allow answers in the range of 4.8 to $4.9 \times 10^{-21} \text{ J}$ if 2 sig figs or more are used.

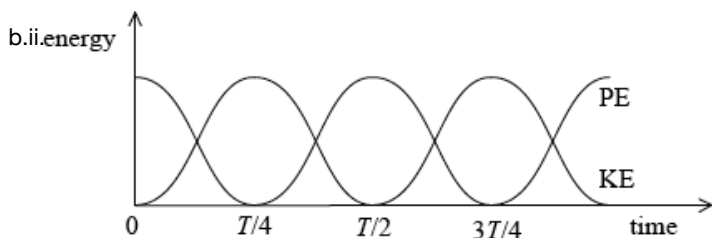

KE and PE curves labelled – very roughly \cos^2 and \sin^2 shapes; } (allow reversal of curve labels)

KE and PE curves in anti-phase and of equal amplitude;

at least one period shown;

either E_{\max} marked correctly on energy axis, or T marked correctly on time axis;

$$\text{c.i. } 7.0 \times 10^{12} \text{ Hz is equivalent to wavelength of } 4.3 \times 10^{-5} \text{ m};$$

$$\text{d.i. number of fissions in one day} = 9.5 \times 10^{19} \times 24 \times 3600 (= 8.2 \times 10^{24});$$

$$\text{mass of uranium atom} = 235 \times 1.661 \times 10^{-27} (= 3.9 \times 10^{-25} \text{ kg});$$

$$\text{mass of uranium in one day} (= 8.2 \times 10^{24} \times 3.9 \times 10^{-25}) = 3.2 \text{ kg};$$

$$\text{d.ii. energy per fission} = 200 \times 10^6 \times 1.6 \times 10^{-19} (= 3.2 \times 10^{-11} \text{ J});$$

$$\text{power output} = (9.5 \times 10^{19} \times 3.2 \times 10^{-11} \times 0.32 =) 9.7 \times 10^8 \text{ W};$$

Award [1] for an answer of $6.1 \times 10^{27} \text{ eVs}^{-1}$.

e.i. neutrons have to be slowed down (before next fission);

because the probability of fission is (much) greater (with neutrons of thermal energy);

neutrons collide with/transfer energy to atoms/molecules (of the moderator);

e.ii. have high neutron capture cross-section/good at absorbing neutrons;

(remove neutrons from the reaction) thus controlling the rate of nuclear reaction;

Examiners report

a.i. This is a slightly different situation. Most candidates at SL did not use F and m to find acceleration. Very few added the force due to each spring and ECF was frequently applied.

a.ii. [N/A]

a.iii. [N/A]

b.i. [N/A]

b.ii. Care was needed in showing the constant and equal amplitudes. Many poor answers were seen.

c.i. [N/A]

d.i. [N/A]

d.ii. [N/A]

e.i. Mostly good answers although it was rare to find a candidate who stated that the probability of further fusion is increased with thermal neutrons.

e.ii. Too many answers lacked precision referring only to the use of control rods in avoiding an explosion or meltdown.

This question is about simple harmonic motion (SHM).

The graph shows the variation with time t of the acceleration a of an object X undergoing simple harmonic motion (SHM).

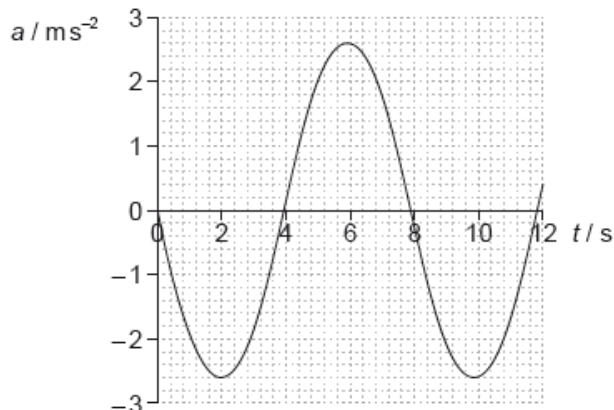

- a. Define simple harmonic motion (SHM). [2]
- b. X has a mass of 0.28 kg. Calculate the maximum force acting on X. [1]
- c. Determine the maximum displacement of X. Give your answer to an appropriate number of significant figures. [4]
- d. A second object Y oscillates with the same frequency as X but with a phase difference of $\frac{\pi}{4}$. Sketch, using the graph opposite, how the acceleration of object Y varies with t . [2]

Markscheme

- a. force/acceleration proportional to the displacement/distance from a (fixed/equilibrium) point/mean position;
directed towards this (equilibrium) point / in opposite direction to displacement/ distance;
Allow algebra only if symbols are fully explained.
- b. 0.73 (N); *(allow answer in range of 0.71 to 0.75 (N))*
- c. use of $a_0 = -\omega^2 x_0$;
 $T = 7.9$ (s) **or** $\omega = 0.795$ **or** $\frac{\pi}{4}$ (rad s⁻¹); *(allow answers in the range of $T = 7.8$ to 8.0 (s) **or** $\omega = 0.785$ to 0.805 (rad s⁻¹))*
 $x_0 = 4.1(1)$ (m); *(allow answers in the range of 4.0 to 4.25 (m))*
two significant figures in final answer whatever the value;
Award [4] for a bald correct answer.
- d. shape correct, constant amplitude for new curve, minimum of 10 s shown; *(there must be some consistent lead or lag and no change in T)*
lead/lag of 1 s (to within half a square by eye);

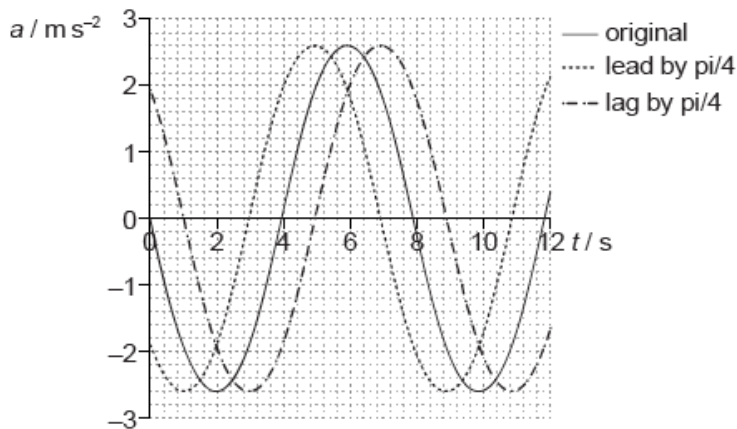

Examiners report

- A good definition of simple harmonic motion must focus on the proportionality between acceleration and displacement *from some fixed point* and on the directional relationship between acceleration and displacement. Many failed to emphasise the fixed-point aspect of the definition. Attempts made to define simple harmonic motion in algebraic terms normally omitted a clear statement of the symbols and the meaning of the negative sign.
- This was almost universally well done.
- Similarly, this was well done. Most appreciated the need to truncate the final answer to a sensible number of significant digits (two in this case).
- A large number of candidates could not translate a $\frac{\pi}{4}$ phase change into the correct time lead or lag. Most used the answer for $\frac{\pi}{2}$ and lost a mark in consequence. Most free-hand sketches of sine curves were acceptable.

This question is in **two** parts. **Part 1** is about the nuclear model of the atom and radioactive decay. **Part 2** is about waves.

Part 1 Nuclear model of the atom and radioactive decay

The nuclide radium-226 (${}^{226}_{88}\text{Ra}$) decays into an isotope of radon (Rn) by the emission of an alpha particle and a gamma-ray photon.

Part 2 Waves

Two waves, A and B, are travelling in opposite directions in a tank of water. The graph shows the variation of displacement of the water surface with distance along the wave at a particular instant.

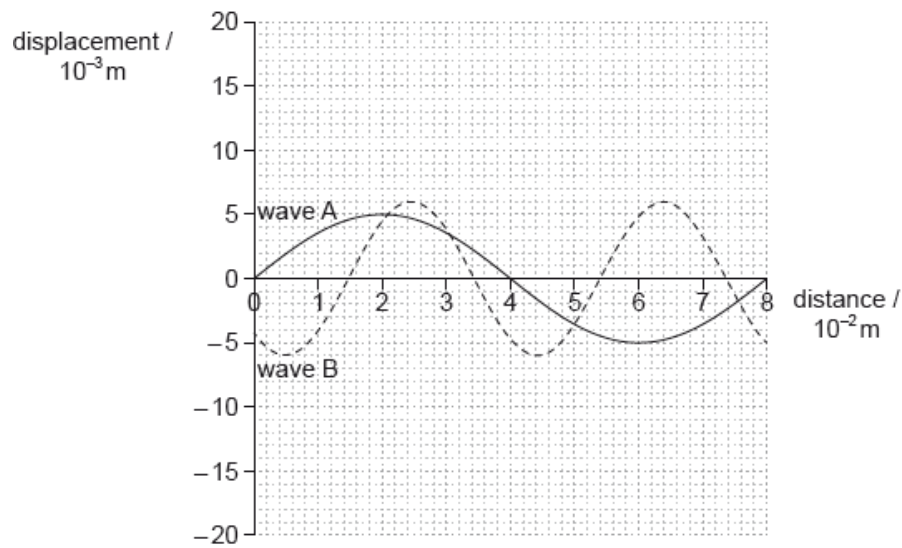

- a. Outline how the evidence supplied by the Geiger–Marsden experiment supports the nuclear model of the atom. [4]
- b. Outline why classical physics does not permit a model of an electron orbiting the nucleus. [3]
- c.i. State what is meant by the terms nuclide and isotope. [2]

Nuclide:

Isotope:

- c.ii. Construct the nuclear equation for the decay of radium-226. [3]

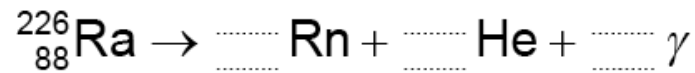

- c.iii. Radium-226 has a half-life of 1600 years. Determine the time, in years, it takes for the activity of radium-226 to fall to $\frac{1}{64}$ of its original activity. [2]

- d. State the amplitude of wave A. [1]

- e.i. Wave A has a frequency of 9.0 Hz. Calculate the velocity of wave A. [2]

- e.ii. Deduce the frequency of wave B. [3]

- f.i. State what is meant by the principle of superposition of waves. [2]

- f.ii. On the graph opposite, sketch the wave that results from the superposition of wave A and wave B at that instant. [3]

Markscheme

- a. most undeflected/pass straight through;
 hence mostly empty space;
 few deflected; (allow “bent”, “reflect”, “bounce back” etc)
 hence small dense nucleus;
 positive / positively charged;

b. electron accelerated / mention of centripetal force;

should radiate EM waves/energy;

and spiral into the nucleus;

c.i. *nuclide*: nucleus characterized by specified number of protons and neutrons/its constituents;

isotope: nuclide with same number of protons / same element and different numbers of nucleons/neutrons;

c.ii. ${}_{86}^{222}\text{Rn}$;

${}^4_2\text{He}$ **or** ${}^0_0\gamma$;

top and bottom numbers balanced correctly;

c.iii. 6 half-lives occurred;

9600 years;

Award **[2]** for a bald correct answer.

d. 5 mm **or** 5.0 mm; *units are required*

Allow other units, eg: $5/5.0 \times 10^{-3} \text{ m}$.

e.i. wavelength = 8.0 cm **or** 8 cm; (*accept clear substitution in MP2 for this mark*)

$v = (f\lambda) 9 \times 8 = 72 \text{ cm s}^{-1}$; *units are required*

Award **[2]** for a bald correct answer.

e.ii. wavelength = 3.9 (cm); (*accept answers in the range of 3.8 to 4.0 (cm)*)

frequency = $\left(\frac{72}{3.9}\right) 18$;

Hz **or** s^{-1} ;

Award **[3]** for a bald correct answer that includes unit.

f.i. when two or more waves (of the same nature) meet/interfere / OWTTE;

the resultant displacement is the (vector) sum of their individual displacements; } (*do not allow constructive or destructive interference as answer to this point*)

Do not accept "amplitude" for "displacement" anywhere in answer.

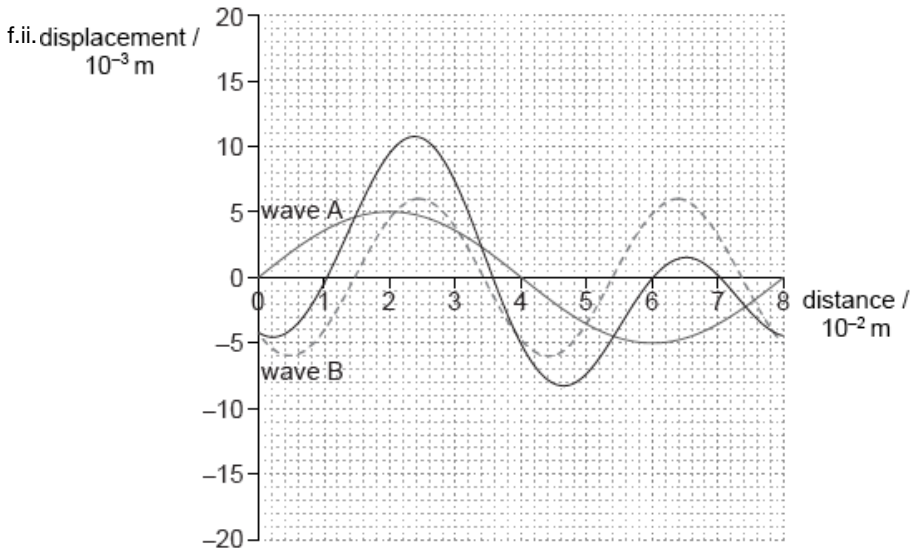

start and end points correct (equal B) and crossing points on distance axis correct (1, 3.6, 6, 7);

peaks and troughs at (2.4, 11) (4.6, - 8) (6.5, 1.5);

general shape correct as in example; } (*maximum and minimum must be alternating +/-*)

All tolerances ± 1 square.

Examiners report

- a. This was generally well done, but too many candidates focused upon a description of the experiment rather than the evidence it provided.
- b. Very poorly done.
- c.i. The word nuclide refers to a nucleus with a specific number of protons and neutrons. Very few candidates understood this. They were, however, mostly able to show a clear understanding of what an isotope was.
- c.ii. No problem for the majority of candidates.
- c.iii. Most candidates were able to give the correct answer.
- d. This was well done – an omission of the vital unit (so that the examiner can confirm the reading) was not too common.
- e.i. This part was well done.
- e.ii. This part was well done.
- f.i. Many candidates described the meeting or interference of two waves, however, a considerable number went on to confuse amplitude with displacement in their answer and lost marks.
- f.ii. This was a demanding drawing requiring candidates to show the complex superposition of two waves. Some candidates rose well to this challenge, took their time, and drew very good attempts. Many however produced rather half-hearted and rushed diagrams that lost one or more marks for lack of quality. Teachers would be advised to study the mark scheme as it gives a sensible route for the construction of the final answer.

This question is in **two** parts. **Part 1** is about simple harmonic motion (SHM) and sound. **Part 2** is about electric and magnetic fields.

Part 1 Simple harmonic motion (SHM) and sound

The diagram shows a section of continuous track of a long-playing (LP) record. The stylus (needle) is placed in the track of the record.

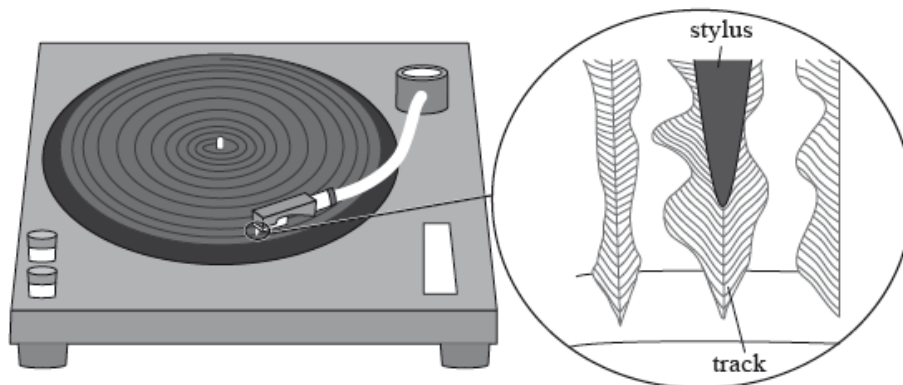

As the LP record rotates, the stylus moves because of changes in the width and position of the track. These movements are converted into sound waves by an electrical system and a loudspeaker.

A recording of a single-frequency musical note is played. The graph shows the variation in horizontal acceleration of the stylus with horizontal displacement.

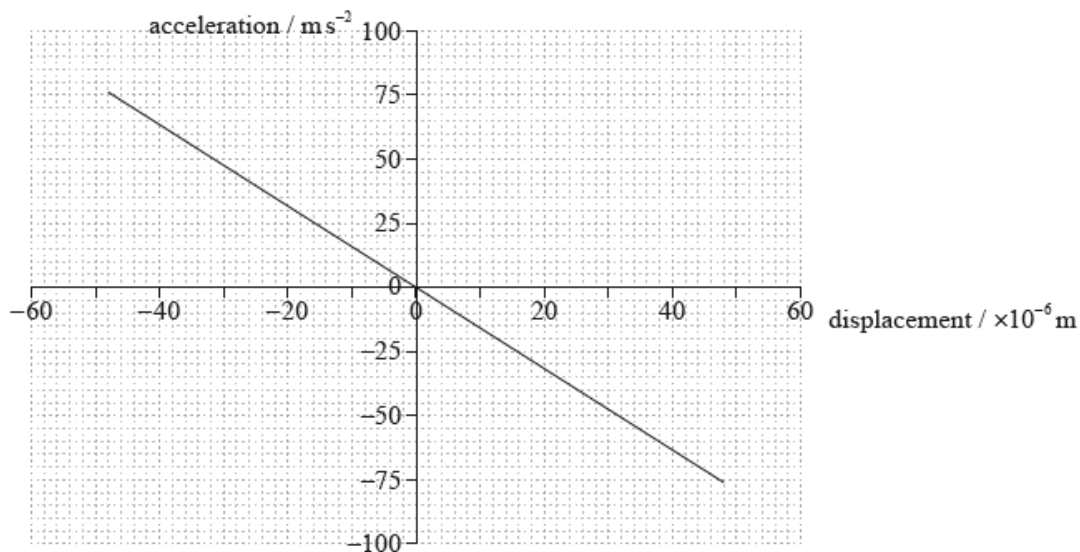

Sound is emitted from a loudspeaker which is outside a building. The loudspeaker emits a sound wave that has the same frequency as the recorded note.

A person standing at position 1 outside the building and a person standing at position 2 inside the building both hear the sound emitted by the loudspeaker.

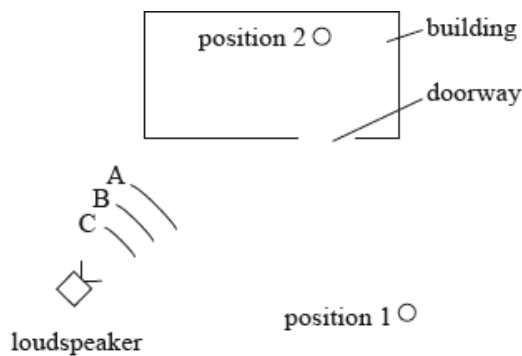

A, B and C are wavefronts emitted by the loudspeaker.

Part 2 Electric and magnetic fields

Electrical leads used in physics laboratories consist of a central conductor surrounded by an insulator.

- Explain why the graph shows that the stylus undergoes simple harmonic motion. [4]
- Using the graph on page 14, show that the frequency of the note being played is about 200 Hz. [5]
 - On the graph on page 14, identify, with the letter P, the position of the stylus at which the kinetic energy is at a maximum.
- Draw rays to show how the person at **position 1** is able to hear the sound emitted by the loudspeaker. [4]
 - The speed of sound in the air is 330 m s^{-1} . Calculate the wavelength of the note.
 - The walls of the room are designed to absorb sound. Explain how the person at **position 2** is able to hear the sound emitted by the loudspeaker.
- The arrangement in (c) is changed and another loudspeaker is added. Both loudspeakers emit the same recorded note in phase with each other. [3]

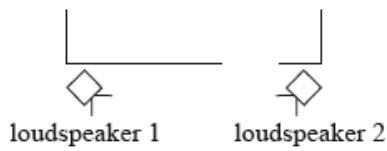

Outline why there are positions between the loudspeakers where the sound can only be heard faintly.

e. Distinguish between an insulator and a conductor. [2]

f. The diagram shows a current I in a vertical wire that passes through a hole in a horizontal piece of cardboard. [3]

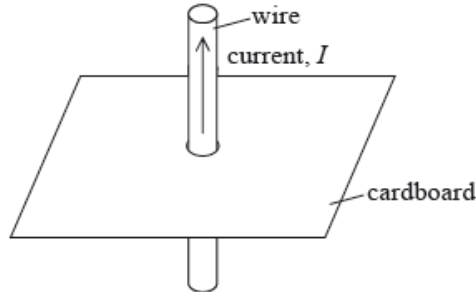

On the cardboard, draw the magnetic field pattern due to the current.

g. (i) The diagram shows a length of copper wire that is horizontal in the magnetic field of the Earth. [4]

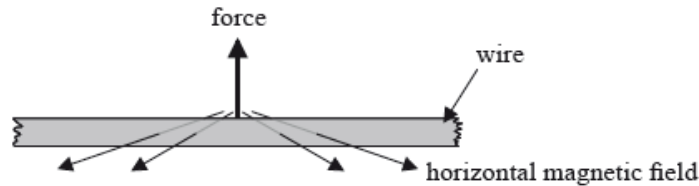

The wire carries an electric current and the force on the wire is as shown. Identify, with an arrow, the direction of electron flow in the wire.

(ii) The horizontal component of the magnetic field of the Earth at the position of the wire is $40 \mu\text{T}$. The mass per unit length of the wire is $1.41 \times 10^{-4} \text{ kg m}^{-2}$. The net force on the wire is zero. Determine the current in the wire.

Markscheme

a. acceleration is proportional to displacement;

force/acceleration is directed towards equilibrium (point)/rest position; } (do not accept "centre" or "fixed" point)

straight line through the origin shows the proportionality;

negative gradient shows acceleration directed towards equilibrium (point) / acceleration has opposite sign to displacement;

b. (i) gradient = $(-)\omega^2$;

$$\omega^2 = 1.56 \times 10^6 \text{ (s}^{-2}\text{)};$$

$$\omega = 1250 \text{ (rad s}^{-1}\text{)};$$

$$f = 198 \text{ (Hz)};$$

or

$$\omega^2 = (-)\frac{a}{x};$$

$$\omega = \sqrt{\frac{75}{48 \times 10^{-6}}};$$

$$f = \frac{1}{2\pi} \sqrt{\frac{75}{48 \times 10^{-6}}};$$

$$f = 198 \text{ (Hz)};$$

Allow substitution for fourth mark.

- (ii) at origin;
- c. (i) ray shown at 90° to wavefront A, plausible reflection and reflected ray goes in direction of position 1; } (*judge by eye*)
- (ii) 1.65 (m); (*allow ECF from (b)*) (*accept rounding to 1.6 or 1.7*)
- (iii) mention of diffraction;
- diffraction means that sound spreads beyond the limit of geometrical shadow/can go around a corner / *OWTTE*;
- Accept marking points in the form of a clearly drawn correctly labelled diagram.*
- d. interference/superposition mentioned;
- when sounds arrive out of phase / path difference half integer number of wavelengths / *OWTTE*;
- cancellation occurs / destructive (interference);
- some (back) reflection from walls so cancellation may not be complete (hence “faint” not “zero”);
- e. conductor has free electrons/charges that are free to move within/through it / insulator does not have free electrons/charges that are free to move within/ through it;
- electrons act as charge carriers;
- when a pd acts across a conductor a current exists when charge (carriers) move;
- Do not allow “good/bad conductor/resistor” or reference to conductivity/resistivity.*
- f. anti-clockwise arrows;
- at least three circles centred on wire;
- increasing in separation from centre;
- g. (i) arrow to the right;
- (ii) $\frac{F}{l} = BI$;
- $$I = \left(\frac{mg}{lB} = \right) \frac{1.41 \times 10^{-4} \times 9.8}{40 \times 10^{-6}};$$
- 35 (A);
- Award [3] for a bald correct answer.*
- Allow use of $g = 10 \text{ m s}^{-2}$ which also gives an answer of 35 (A).*

Examiners report

- a. It was rare to see all four marks awarded for statements of the requirements of harmonic oscillation and recognition of these in the straight-line graph. Candidates were generally happy to state that acceleration is directly proportional to displacement and that the straight line through the origin confirmed this. Correct statements with appropriate detail of the direction of the force/acceleration were rarer and the negative gradient was not often mentioned. Four marks were available and therefore candidates should have recognised that four points were required.
- b. (i) This calculation was poorly done.
- (ii) P – when it was marked on the graph at all – was either shown at the origin (correct) or one extreme (incorrect) of the graph in about equal numbers.

- c. (i) Candidates are required to know the relationship between wavefronts and rays and it was surprising that many completed the diagram with wavefronts – and even these would not have gained much credit given the very poor draughtsmanship in evidence. Few candidates bothered to read the question. They failed to realise that all they were required to do was construct plausible incident and reflected rays that would enable the observer at point 1 to hear the sound.
- (ii) There were many examples of correct evaluation of the wavelength of the sound but far too many were unable to complete this simple task. Inversions of the equation and mistakes in powers of ten and in rounding were common.
- (iii) The usual phonetic spelling of “defraction” was observed. Examiners are unlikely to give a benefit of the doubt to what might have been a phonetic spelling or might equally have been confusion with “refraction” in this particular case. Many candidates were able to spot that the sound was being diffracted but an explanation of what diffraction is, in context, was much rarer.
- d. [N/A]
- e. Superficial answers were common. Candidates continue to ignore the mark allocations for questions and therefore the number of independent points they should mention in an answer. Here, most said that conductors contain free electrons (or the reverse for insulators) but did not go on to discuss the role of the free electrons in carrying charge or to relate the current to the existence of an electric field across the conductor. Far too many gave answers of the “conductors conduct well” variety that do not score marks.
- f. There are three elements to a good drawing of the magnetic field around a long straight conductor: the concentric circularity of the lines, the direction of the lines related to the direction of charge flow, and the increasing separation between lines as the distance from the conductor increases. It was a rare candidate who was able to convince the examiner with all three points. In hindsight, the diagram could have been larger on the page. However, candidates could have taken more trouble over their sketches which were usually crude.
- g. (i) Many forgot that the sign rules involve conventional current and lost the mark.
- (ii) Few correct solutions were observed. This was a straightforward problem involving one re-arrangement of a standard equation and the incorporation of the weight of the conductor.

- a. Outline what is meant by the principle of superposition of waves. [2]
- b. Red laser light is incident on a double slit with a slit separation of 0.35 mm. [3]
- A double-slit interference pattern is observed on a screen 2.4 m from the slits.
- The distance between successive maxima on the screen is 4.7 mm.

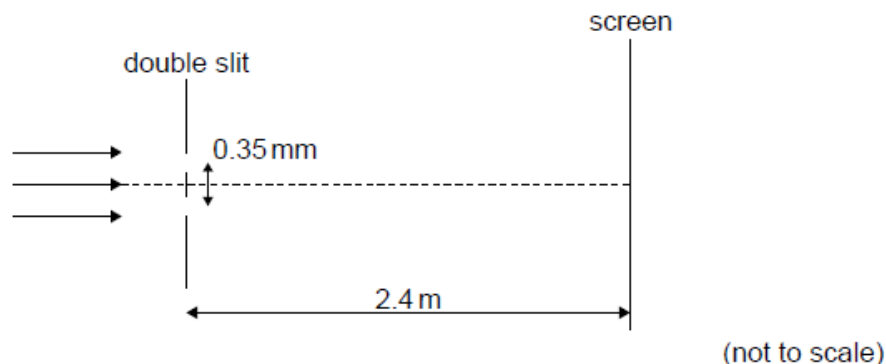

Calculate the wavelength of the light. Give your answer to an appropriate number of significant figures.

- c. Explain the change to the appearance of the interference pattern when the red-light laser is replaced by one that emits green light. [2]

- d. One of the slits is now covered.

Describe the appearance of the pattern on the screen.

Markscheme

- a. when 2 waves meet the resultant displacement

is the «vector» sum of their individual displacements

Displacement should be mentioned at least once in MP 1 or 2.

b. $\lambda = \frac{4.7 \times 10^{-3} \times 0.35 \times 10^{-3}}{2.4}$

$= 6.9 \times 10^{-7}$ «m»

answer to 2 SF

Allow missed powers of 10 for MP1.

- c. green wavelength smaller than red

fringe separation / distance between maxima decreases

Allow ECF from MP1.

- d. bright central maximum

subsidiary maxima «on either side»

the width of the central fringe is twice / larger than the width of the subsidiary/secondary fringes/maxima

OR

intensity of pattern is decreased

Allow marks from a suitably labelled intensity graph for single slit diffraction.

Examiners report

- a. [N/A]
 b. [N/A]
 c. [N/A]
 d. [N/A]

A loudspeaker emits sound towards the open end of a pipe. The other end is closed. A standing wave is formed in the pipe. The diagram represents the displacement of molecules of air in the pipe at an instant of time.

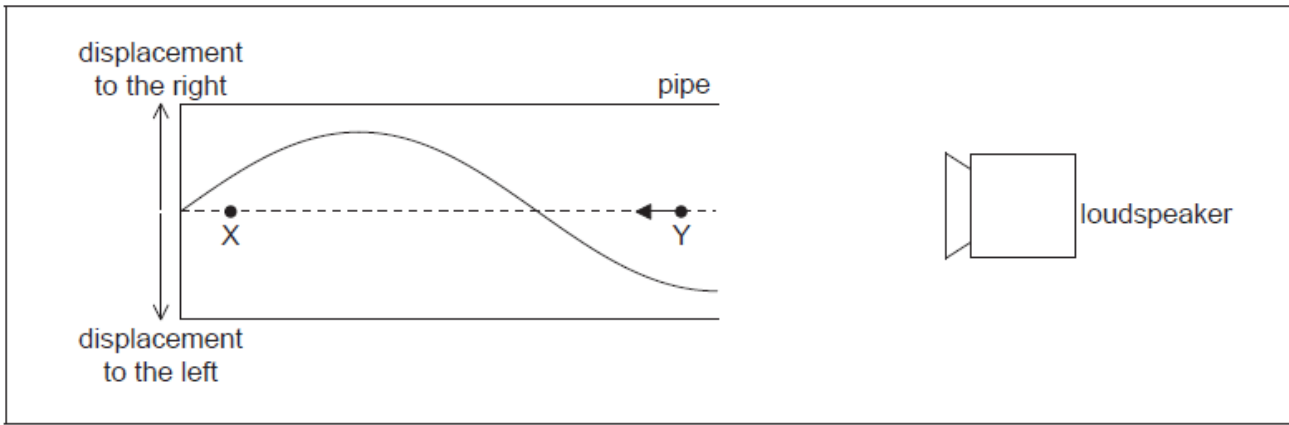

X and Y represent the equilibrium positions of two air molecules in the pipe. The arrow represents the velocity of the molecule at Y.

The loudspeaker in (a) now emits sound towards an air–water boundary. A, B and C are parallel wavefronts emitted by the loudspeaker. The parts of wavefronts A and B in water are not shown. Wavefront C has not yet entered the water.

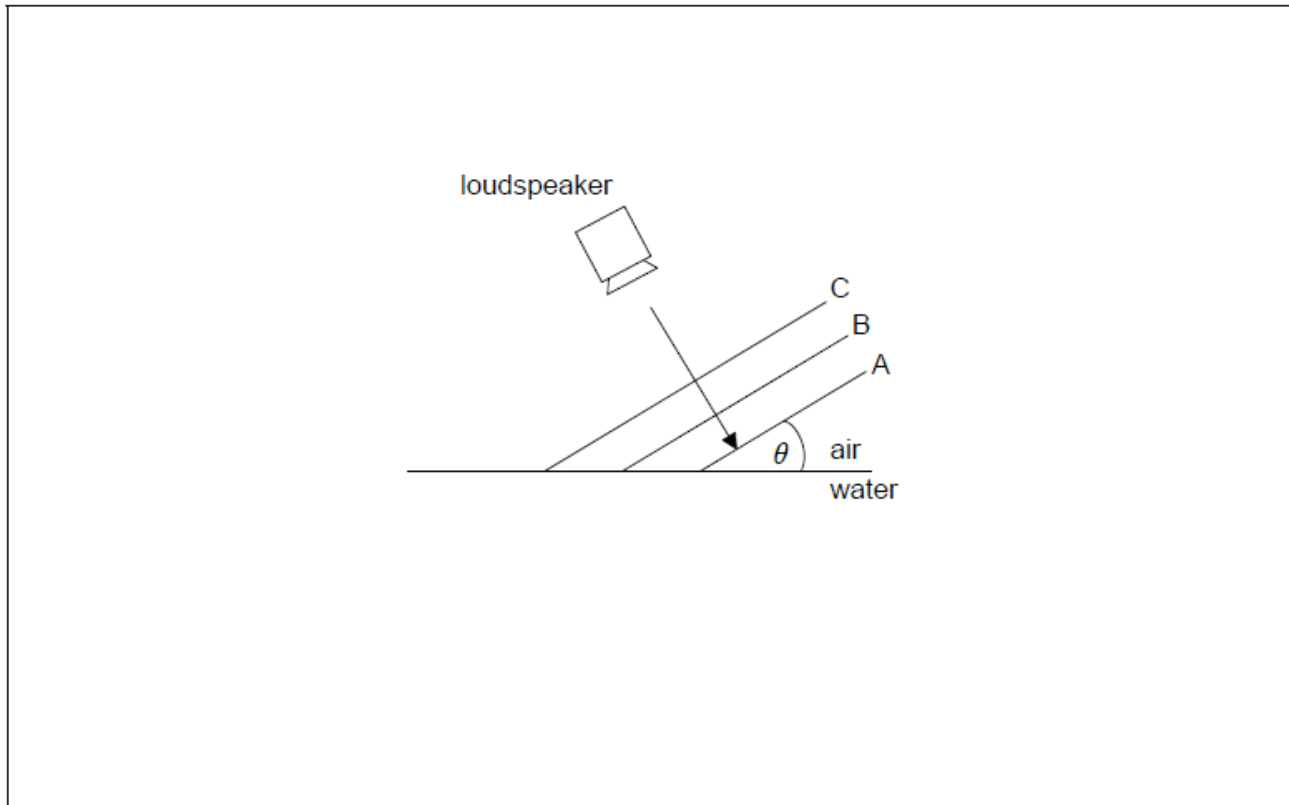

- a.i. Outline how the standing wave is formed. [1]
- a.ii. Draw an arrow on the diagram to represent the direction of motion of the molecule at X. [1]
- a.iii. Label a position N that is a node of the standing wave. [1]
- a.iv. The speed of sound is 340 m s^{-1} and the length of the pipe is 0.30 m . Calculate, in Hz, the frequency of the sound. [2]
- b.i. The speed of sound in air is 340 m s^{-1} and in water it is 1500 m s^{-1} . [2]

The wavefronts make an angle θ with the surface of the water. Determine the maximum angle, θ_{max} , at which the sound can enter water. Give your answer to the correct number of significant figures.

b.ii. Draw lines on the diagram to complete wavefronts A and B in water for $\theta < \theta_{\max}$.

[2]

Markscheme

a.i. the incident wave «from the speaker» and the reflected wave «from the closed end»

superpose/combine/interfere

Allow superimpose/add up

Do not allow meet/interact

[1 mark]

a.ii. Horizontal arrow from X to the right

MP2 is dependent on MP1

Ignore length of arrow

[1 mark]

a.iii. P at a node

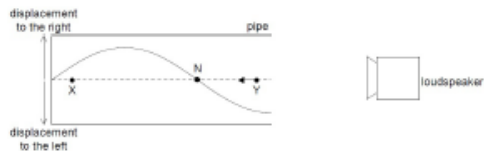

[1 mark]

a.i. wavelength is $\lambda = \frac{4 \times 0.30}{3} \Rightarrow 0.40$ «m»

$$f = \frac{340}{0.40} \Rightarrow 850 \text{ «Hz»}$$

Award [2] for a bald correct answer

Allow ECF from MP1

[2 marks]

b.i. $\frac{\sin \theta_c}{340} = \frac{1}{1500}$

$$\theta_c = 13 \text{ «}^\circ \text{»}$$

Award [2] for a bald correct answer

Award [2] for a bald answer of 13.1

Answer must be to 2/3 significant figures to award MP2

Allow 0.23 radians

[2 marks]

b.ii. correct orientation

greater separation

Do not penalize the lengths of A and B in the water

Do not penalize a wavefront for C if it is consistent with A and B

MP1 must be awarded for MP2 to be awarded

eg:

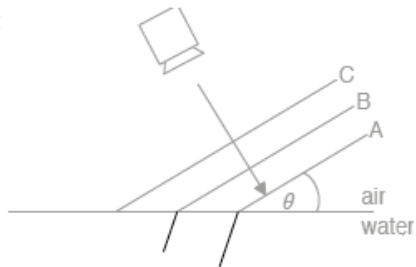

[2 marks]

Examiners report

- a.i. [N/A]
- a.ii. [N/A]
- a.iii. [N/A]
- a.iv. [N/A]
- b.i. [N/A]
- b.ii. [N/A]

A large cube is formed from ice. A light ray is incident from a vacuum at an angle of 46° to the normal on one surface of the cube. The light ray is parallel to the plane of one of the sides of the cube. The angle of refraction inside the cube is 33° .

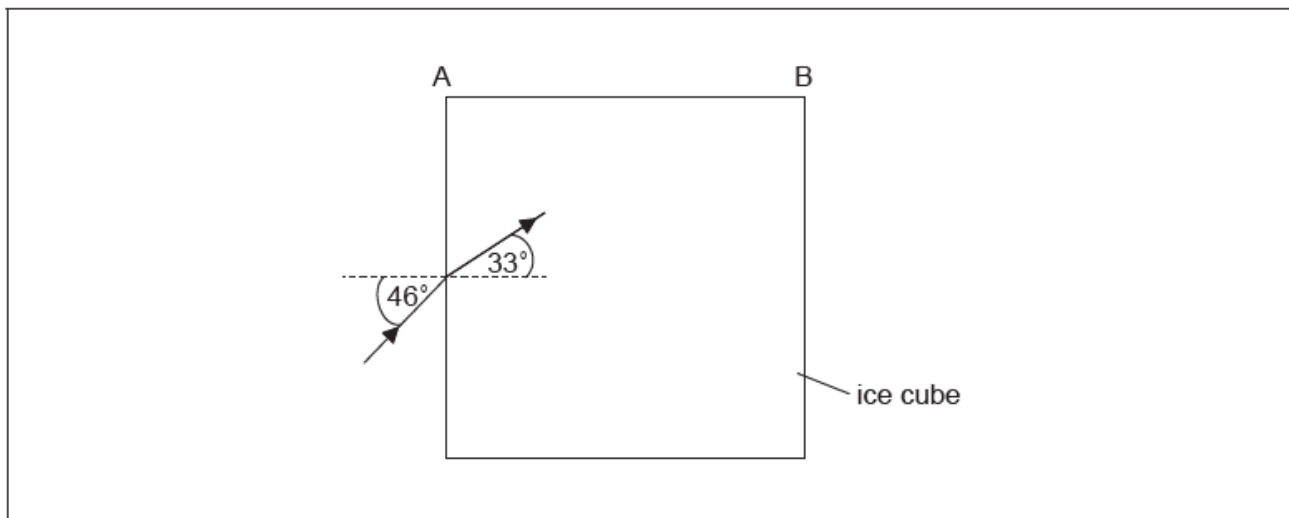

Each side of the ice cube is 0.75 m in length. The initial temperature of the ice cube is -20°C .

a.i. Calculate the speed of light inside the ice cube.

[2]

a.ii. Show that no light emerges from side AB.

[3]

a.iii Sketch, on the diagram, the subsequent path of the light ray.

[2]

b.i. Determine the energy required to melt all of the ice from $-20\text{ }^{\circ}\text{C}$ to water at a temperature of $0\text{ }^{\circ}\text{C}$.

[4]

Specific latent heat of fusion of ice = 330 kJ kg^{-1}
Specific heat capacity of ice = $2.1\text{ kJ kg}^{-1}\text{ K}^{-1}$
Density of ice = 920 kg m^{-3}

b.ii. Outline the difference between the molecular structure of a solid and a liquid.

[1]

Markscheme

a.i. $v = c \frac{\sin i}{\sin r} \Rightarrow \frac{3 \times 10^8 \times \sin(33)}{\sin(46)}$

$2.3 \times 10^8\text{ m s}^{-1}$

a.ii. light strikes AB at an angle of 57°

critical angle is $\sin^{-1}\left(\frac{2.3}{3}\right) \Rightarrow 50.1^{\circ}$

49.2° from unrounded value

angle of incidence is greater than critical angle so total internal reflection

OR

light strikes AB at an angle of 57°

calculation showing \sin of "refracted angle" = 1.1

statement that since $1.1 > 1$ the angle does not exist and the light does not emerge

[Max 3 marks]

a.iii. total internal reflection shown

ray emerges at opposite face to incidence

Judge angle of incidence = angle of reflection by eye or accept correctly labelled angles

With sensible refraction in correct direction

b.i. mass = $\text{volume} \times \text{density}$ $(0.75)^3 \times 920 \approx 388\text{ kg}$

energy required to raise temperature = $388 \times 2100 \times 20 \approx 1.63 \times 10^7\text{ J}$

energy required to melt = $388 \times 330 \times 10^3 \approx 1.28 \times 10^8\text{ J}$

$1.4 \times 10^8\text{ J}$ **OR** $1.4 \times 10^5\text{ kJ}$

Accept any consistent units

Award [3 max] for answer which uses density as 1000 kg m^{-3} ($1.5 \times 10^8\text{ J}$)

b.ii. in solid state, nearest neighbour molecules cannot exchange places/have fixed positions/are closer to each other/have regular pattern/have

stronger forces of attraction

in liquid, bonds between molecules can be broken and re-form

OWTTE

Accept converse argument for liquids

[Max 1 Mark]

Examiners report

- a.i. [N/A]
- a.ii. [N/A]
- a.iii. [N/A]
- b.i. [N/A]
- b.ii. [N/A]

- a. Two microwave transmitters, X and Y, are placed 12 cm apart and are connected to the same source. A single receiver is placed 54 cm away and moves along a line AB that is parallel to the line joining X and Y. [4]

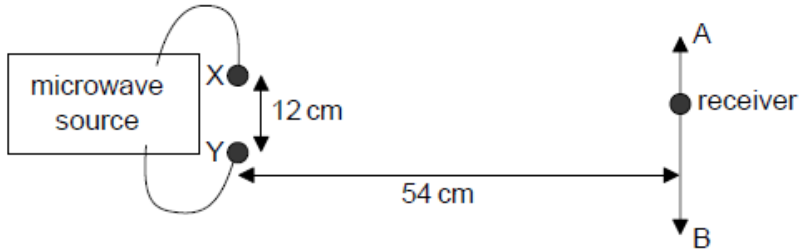

Maxima and minima of intensity are detected at several points along AB.

- (i) Explain the formation of the intensity **minima**.
 - (ii) The distance between the central maximum and the first minimum is 7.2 cm. Calculate the wavelength of the microwaves.
- b. Radio waves are emitted by a straight conducting rod antenna (aerial). The plane of polarization of these waves is parallel to the transmitting antenna. [2]
- antenna.

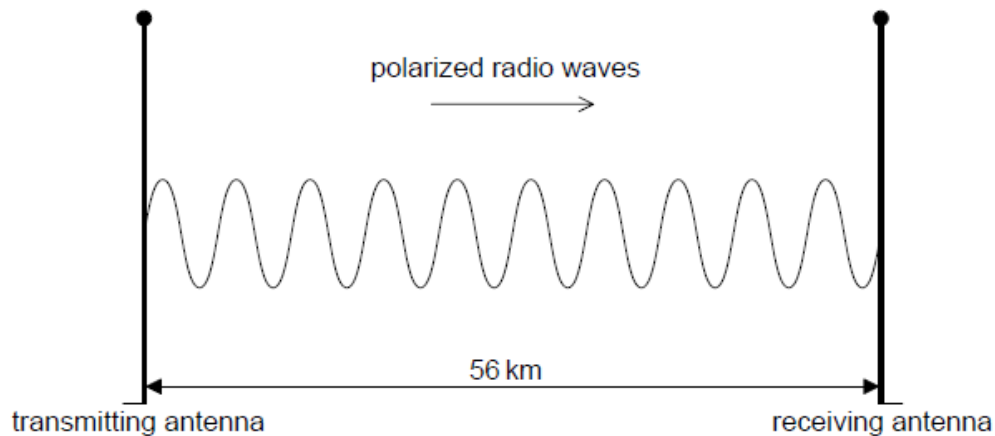

An identical antenna is used for reception. Suggest why the receiving antenna needs to be parallel to the transmitting antenna.

- c. The receiving antenna becomes misaligned by 30° to its original position. [3]

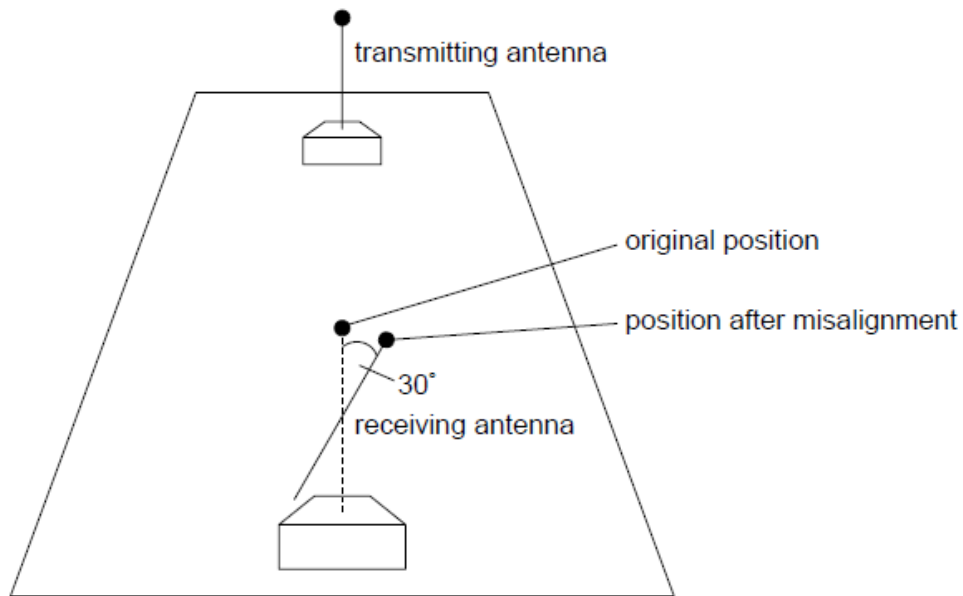

The power of the received signal in this new position is $12 \mu\text{W}$.

(i) Calculate the power that was received in the original position.

(ii) Calculate the minimum time between the wave leaving the transmitting antenna and its reception.

Markscheme

a. i

minima = destructive interference

Allow "crest meets trough", but not "waves cancel".

Allow "destructive superposition" but not bald "superposition".

at minima waves meet 180° **or** π out of phase

Allow similar argument in terms of effective path difference of $\frac{\lambda}{2}$.

Allow "antiphase", allow "completely out of phase"

Do not allow "out of phase" without angle. Do not allow $\frac{n\lambda}{2}$ unless qualified to odd integers but accept $(n + \frac{1}{2}) \lambda$

ii

$$\lambda = \frac{sd}{D} \text{ or } \lambda = \frac{12 \times 2 \times 7.2}{54} = \text{or } \lambda = \frac{12 \times 7.2}{54} = \text{seen}$$

Award **[2]** for a bald correct answer.

$$\lambda = \left\langle \frac{12 \times 2 \times 7.2}{54} \right\rangle \Rightarrow 3.2 \text{ «cm»}$$

Award **[1 max]** for 1.6 «cm»

Award **[2 max]** to a trigonometric solution in which candidate works out individual path lengths and equates to $\frac{\lambda}{2}$.

b. **ALTERNATIVE 1**

the component of the polarized signal in the direction of the receiving antenna

is a maximum «when both are parallel»

ALTERNATIVE 2:

receiving antenna must be parallel to plane of polarisation
for power/intensity to be maximum

Do not accept “receiving antenna must be parallel to transmitting antenna”

ALTERNATIVE 3:

refers to Malus' law **or** $I = I_0 \cos^2\theta$

explains that I is max when $\theta = 0$

ALTERNATIVE 4:

an electric current is established in the receiving antenna which is proportional to the electric field
maximum current in receiving antenna requires maximum field «and so must be parallel»

c. i

$$I_0 = \frac{I}{\cos^2\theta} \text{ or } \frac{12}{\cos^2 30} \text{ seen}$$

Award [2] for bald correct answer.

Award [1 max] for MP1 if $9 \times 10^{-6} \text{W}$ is the final answer (I and I_0 reversed).

Award [1 max] if cos not squared ($14 \mu\text{W}$).

$$1.6 \times 10^{-5} \text{W}$$

Units not required but if absent assume W.

ii

$$1.9 \times 10^{-4} \text{S}$$

Examiners report

- a. [N/A]
- b. [N/A]
- c. [N/A]

A student investigates how light can be used to measure the speed of a toy train.

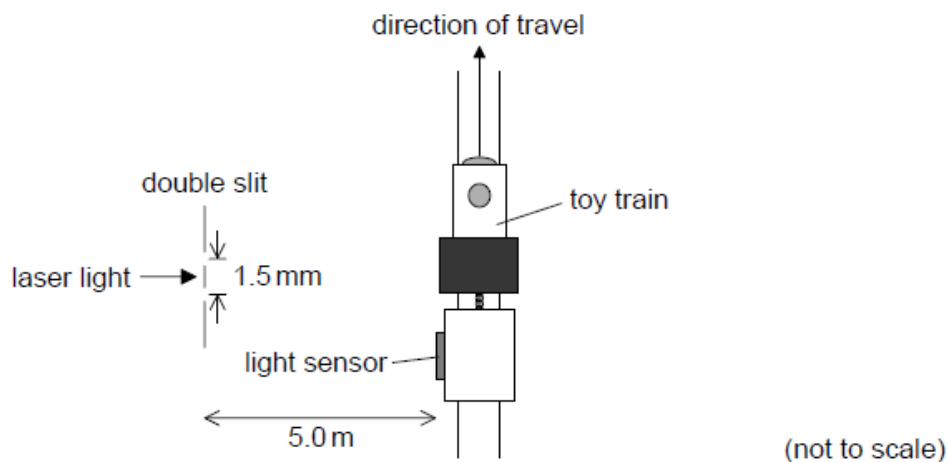

Light from a laser is incident on a double slit. The light from the slits is detected by a light sensor attached to the train.

The graph shows the variation with time of the output voltage from the light sensor as the train moves parallel to the slits. The output voltage is proportional to the intensity of light incident on the sensor.

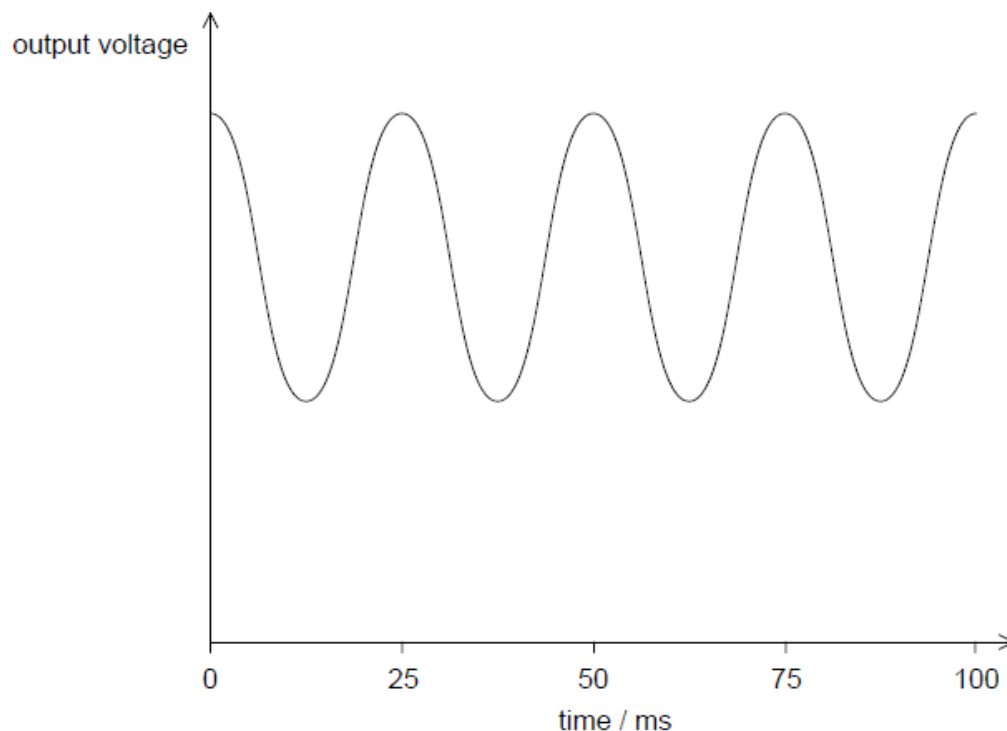

a. Explain, with reference to the light passing through the slits, why a series of voltage peaks occurs. [3]

b.i. The slits are separated by 1.5 mm and the laser light has a wavelength of 6.3×10^{-7} m. The slits are 5.0 m from the train track. Calculate the separation between two adjacent positions of the train when the output voltage is at a maximum. [1]

b.ii. Estimate the speed of the train. [2]

c. In another experiment the student replaces the light sensor with a sound sensor. The train travels away from a loudspeaker that is emitting sound waves of constant amplitude and frequency towards a reflecting barrier. [2]

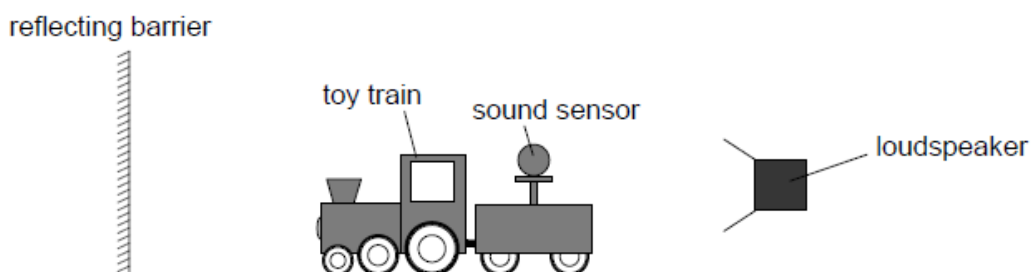

The sound sensor gives a graph of the variation of output voltage with time along the track that is similar in shape to the graph shown in the resource. Explain how this effect arises.

Markscheme

a. «light» superposes/interferes

pattern consists of «intensity» maxima and minima

OR

consisting of constructive and destructive «interference»

voltage peaks correspond to interference maxima

$$\text{b.i. } \llbracket s = \frac{\lambda D}{d} = \frac{6.3 \times 10^{-7} \times 5.0}{1.5 \times 10^{-3}} \Rightarrow 2.1 \times 10^{-3} \llbracket \text{m} \rrbracket$$

If no unit assume m.

Correct answer only.

b.ii. correct read-off from graph of 25 m s

$$v = \llbracket \frac{x}{t} = \frac{2.1 \times 10^{-3}}{25 \times 10^{-3}} \Rightarrow 8.4 \times 10^{-2} \llbracket \text{m s}^{-1} \rrbracket$$

Allow ECF from (b)(i)

c. **ALTERNATIVE 1**

«reflection at barrier» leads to two waves travelling in opposite directions

mention of formation of standing wave

maximum corresponds to antinode/maximum displacement «of air molecules»

OR

complete cancellation at node position

Examiners report

a. [N/A]

b.i. [N/A]

b.ii. [N/A]

c. [N/A]

This question is about the superposition of waves.

a. State what is meant by the principle of superposition of waves.

[1]

b. The diagram shows two point sources of sound, X and Y. Each source emits waves of wavelength 1.1 m and amplitude A. Over the distances

[5]

shown, any decrease in amplitude can be neglected. The two sources vibrate in phase.

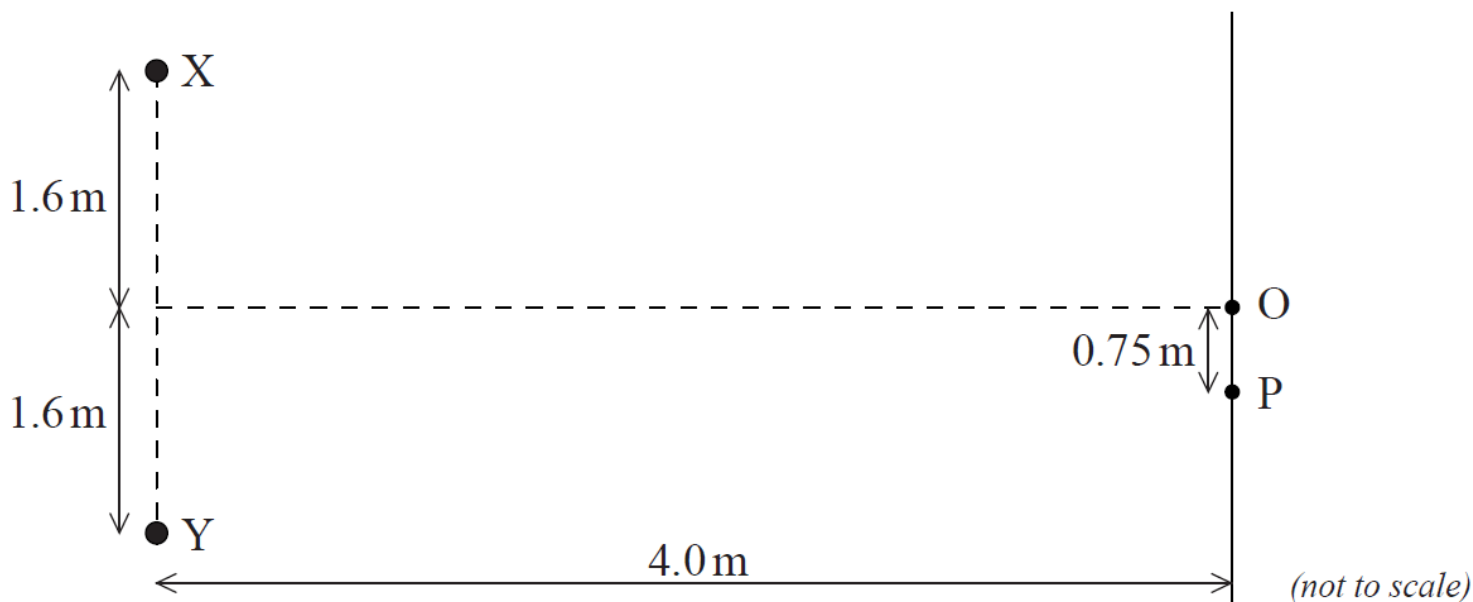

Points O and P are on a line 4.0 m from the line connecting X and Y. O is opposite the midpoint of XY and P is 0.75 m from O.

- Explain why the intensity of the sound at O is $4A^2$.
- Deduce that no sound is detected at P.

Markscheme

- a. (when two similar waves meet) the resultant displacement is the (vector) sum of the individual displacements;

Allow [0] for description in terms of amplitude.

- b. (i) (constructive interference gives) amplitude $2A$; intensity is proportional to square of total amplitude ($=4A^2$);

(ii) attempted use of Pythagoras to measure path difference;

path difference = 0.55 (m);

path difference = $\frac{\lambda}{2}$ (so out of phase / destructive interference);

Attempted use of Pythagoras may appear on diagram for (b)(i).

Examiners report

- a. Few candidates stated the principle of superposition clearly enough to gain a mark – most talked about the sum of the amplitudes rather than of the displacements.

- b. (i) With hindsight having a distance of 4.0m as well as the $4A^2$ was unfortunate and weaker candidates felt obliged to include the distance in their explanation. Of course this did make it clear to examiners that such candidates had very insecure knowledge of this topic. Most answers were unconvincing and highlighted the lack of understanding of this principle.

(ii) A minority of candidates used Pythagoras's theorem to show that the path difference was half a wavelength leading to destructive interference. Weaker candidates tried to argue the case without performing any calculation.

This question is in **two** parts. **Part 1** is about simple harmonic motion (SHM) and waves. **Part 2** is about wind power and the greenhouse effect.

Part 1 Simple harmonic motion (SHM) and waves

a. A gas is contained in a horizontal cylinder by a freely moving piston P. Initially P is at rest at the equilibrium position E.

[2]

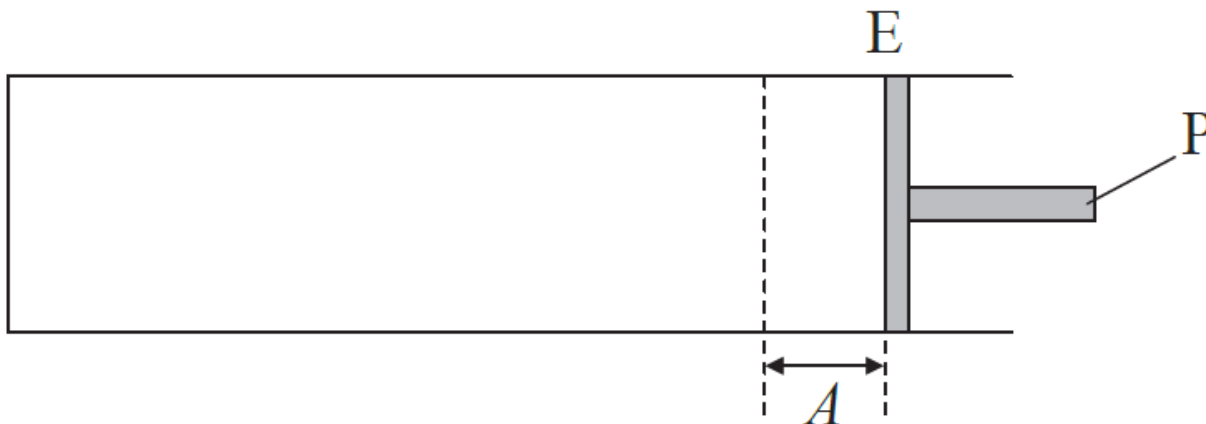

The piston P is displaced a small distance A from E and released. As a result, P executes simple harmonic motion (SHM). Define *simple harmonic motion* as applied to P.

b. The graph shows how the displacement x of the piston P in (a) from equilibrium varies with time t .

[7]

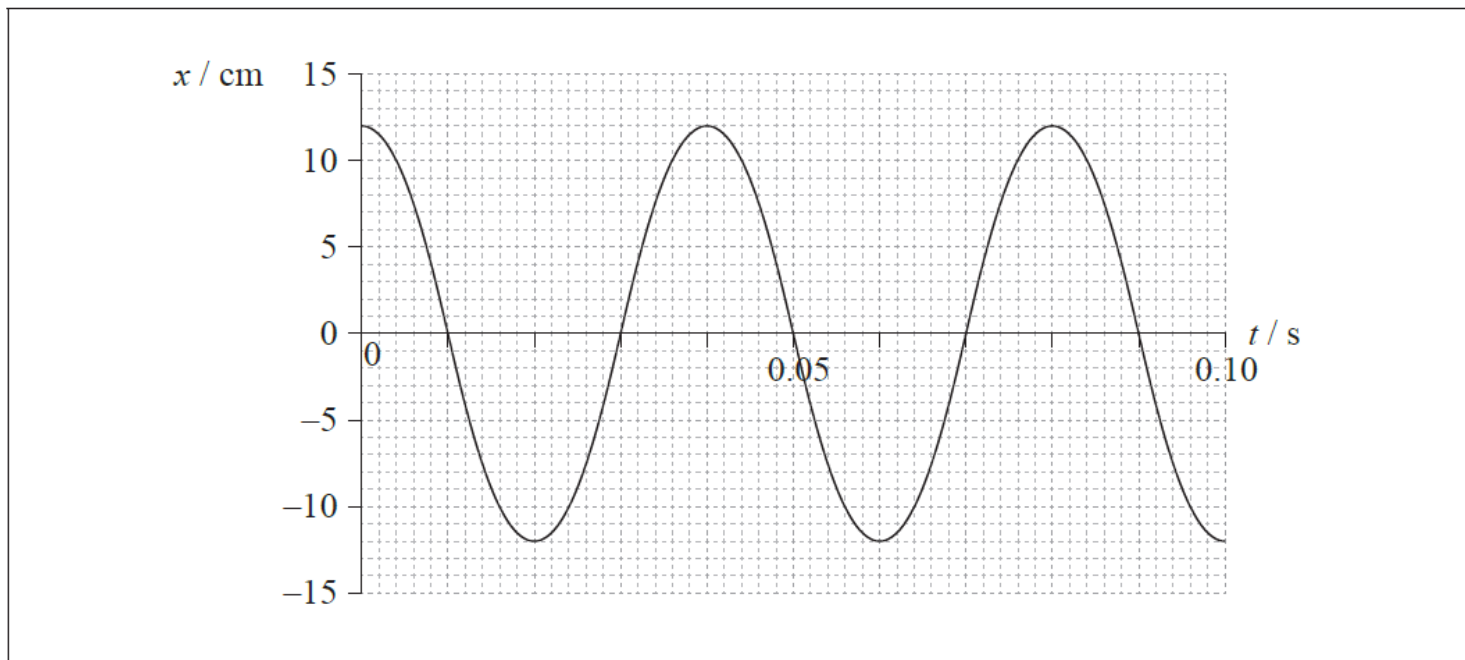

(i) State the value of the displacement A as defined in (a).

(ii) On the graph identify, using the letter M, a point where the magnitude of the acceleration of P is a maximum.

(iii) Determine, using data from the graph and your answer to (b)(i), the magnitude of the maximum acceleration of P.

(iv) The mass of P is 0.32 kg. Determine the kinetic energy of P at $t=0.052$ s.

c. The oscillations of P initially set up a longitudinal wave in the gas.

[4]

(i) Describe, with reference to the transfer of energy, what is meant by a longitudinal wave.

(ii) The speed of the wave in the gas is 340 m s^{-1} . Calculate the wavelength of the wave in the gas.

Markscheme

- a. the acceleration of piston/P is proportional to its displacement from equilibrium;
and directed towards equilibrium;

There must be a clear indication what is accelerating otherwise award [1 max].

- b. (i) 12(cm); (accept -12)

(ii) any maximum or minimum of the graph;

(iii) period = 0.04 (s); (allow clear substitution of this value)

$$\omega = \left(\frac{2\pi}{T} = \right) \frac{2 \times 3.14}{0.04} = 157 \text{ (rads}^{-1}\text{)}$$

maximum acceleration = $(A\omega^2) = 0.12 \times 157^2 = 3.0 \times 10^3 \text{ (ms}^{-2}\text{)}$; (watch for ECF from wrong period)

(iv) at $t = 0.052 \text{ s}$, $x = (-)4(\pm 1) \text{ cm}$;

$$\text{KE} = \left(\frac{1}{2} m \omega^2 [A^2 - x^2] = \right) 0.5 \times 0.32 \times 157^2 [0.12^2 - 0.04^2] = 50 (\pm 7) \text{ (J)}$$

Watch for incorrect use of cm.

Allow ECF from calculations in (b)(iii).

Do not retrospectively credit a mark for ω to (b)(iii) if it was not gained there on original marking.

Allow use of $\sin \omega t$ to obtain v .

Award [2] for a bald correct answer.

- c. (i) the direction of the oscillations/vibrations/movements of the particles (in the medium/gas);

for a longitudinal wave are parallel to the direction of the propagation of the energy of the wave;

$$\text{(ii) } f = \left(\frac{1}{T} = \right) \frac{1}{0.04} = 25 \text{ (Hz)}$$

$$\lambda = \left(\frac{v}{f} = \right) \frac{340}{25} = 14 \text{ (m)}$$

Award [1 max] if frequency is not clearly stated.

Allow ECF from calculations in (b)(iii).

Examiners report

- a. Candidates were asked to define SHM as applied to the situation in the question. Many failed to do this and wrote in general terms about SHM.

- b. (i) This was well done.

(ii) Almost all candidates were able to identify a correct point for the maximum acceleration.

(iii) and (iv) Solutions for these were confused. Some attempted to use kinematic equations. Others mixed metres and centimetres in their answers. Other algebraic errors were present too (e.g. confusing $12^2 - 4^2$ for $(12 - 4)^2$). This is an area that candidates could practice more.

- c. (i) There were three marks for this question: for distinctions between longitudinal and transverse and for a clear description of the point of

comparison. The latter was the mark most frequently lost. Many candidates have the vague idea that something about transverse is perpendicular and that the same parameter is parallel for longitudinal, but what "that something" is was frequently confused.

(ii) Candidates are now taking more care over the clear declaration of the frequency leading to the wavelength.

A longitudinal wave is travelling in a medium from left to right. The graph shows the variation with distance x of the displacement y of the particles in the medium. The solid line and the dotted line show the displacement at $t=0$ and $t=0.882$ ms, respectively.

y / mm

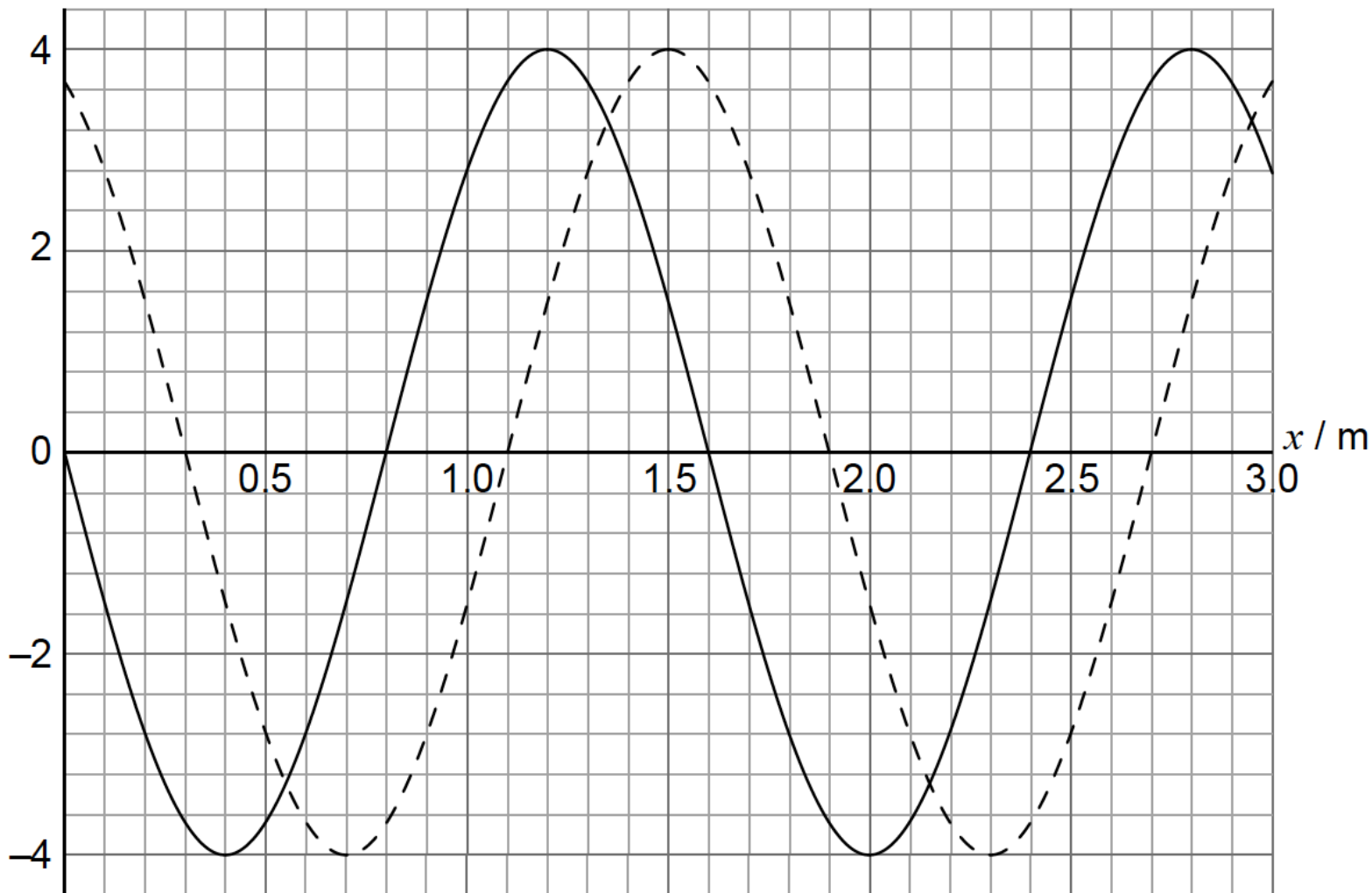

The period of the wave is greater than 0.882 ms. A displacement to the right of the equilibrium position is positive.

- a. State what is meant by a longitudinal travelling wave. [1]

- b. Calculate, for this wave, [4]
 - (i) the speed.
 - (ii) the frequency.

- c. The equilibrium position of a particle in the medium is at $x=0.80$ m. For this particle at $t=0$, state and explain [4]
 - (i) the direction of motion.
 - (ii) whether the particle is at the centre of a compression or a rarefaction.

Markscheme

- a. a wave where the displacement of particles/oscillations of particles/movement of particles/vibrations of particles is parallel to the direction of energy transfer/wave travel/wave movement

Do not allow "direction of wave".

b. (i)

ALTERNATIVE 1

«distance travelled by wave => 0.30 m

$$v = \ll \frac{\text{distance}}{\text{time}} = \gg 340\text{ms}^{-1}$$

ALTERNATIVE 2

evaluates $T = \frac{0.882 \times 10^{-3} \times 1.6}{0.3}$ «=4.7ms» to give $f = 210$ **or** 212 Hz

uses $\lambda = 1.6$ m with $v = f\lambda$ to give 340ms^{-1}

(ii)

ALTERNATIVE 1

$\lambda = 1.60$ m

$$f = \frac{340}{1.60} = 212 \text{ or } 213 \text{ Hz}$$

ALTERNATIVE 2

$$T = \frac{0.882 \times 10^{-3} \times 1.6}{0.3} \text{ «=4.7ms»}$$

$$F = \ll \frac{1}{T} = \gg 210 \text{ Hz}$$

c. (i)

the displacement of the particle decreases **OR** «on the graph» displacement is going in a negative direction **OR** on the graph the particle goes down

to the left

Do not allow "moving downwards" unless accompanied by reference to graph.

(ii)

molecules to the left of the particle have moved left and those to the right have moved right

«hence» the particle is at the centre of a rarefaction

Examiners report

a. [N/A]

b. [N/A]

c. [N/A]

This question is in **two** parts. **Part 1** is about simple harmonic motion (SHM) and waves. **Part 2** is about voltage–current (V – I) characteristics.

Part 1 Simple harmonic motion (SHM) and waves

Part 2 Voltage–current (V – I) characteristics

The graph shows the voltage–current (V – I) characteristics, at constant temperature, of two electrical components X and Y.

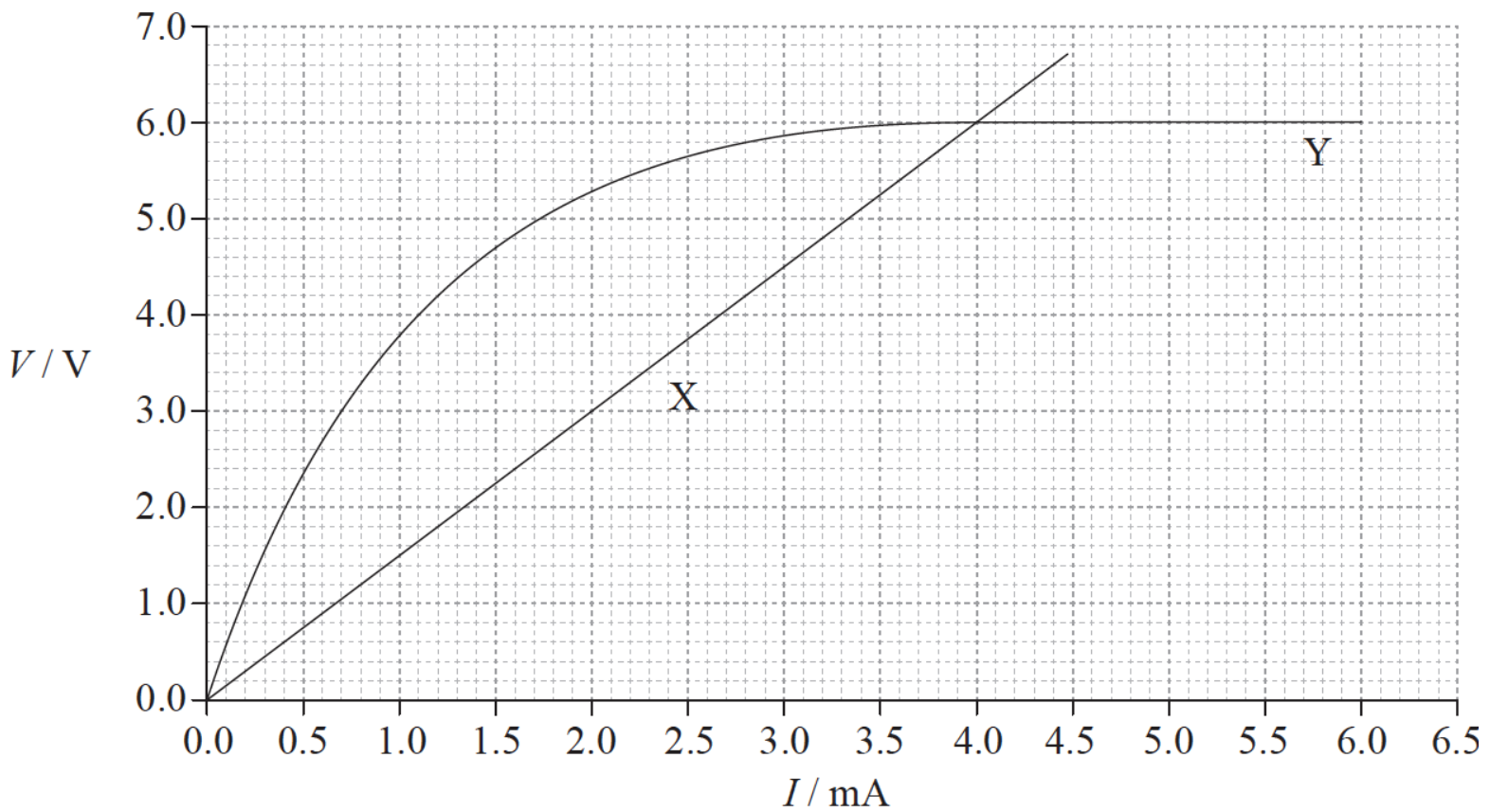

- a. A particle P moves with simple harmonic motion. State, with reference to the motion of P, what is meant by simple harmonic motion. [2]
- b. Use the graph opposite to determine for the motion of P the [7]
- period.
 - amplitude.
 - displacement of P from equilibrium at $t=0.2\text{s}$.
- c. The particle P in (b) is a particle in medium M_1 through which a transverse wave is travelling. [5]
- Describe, in terms of energy propagation, what is meant by a transverse wave.
 - The speed of the wave through the medium is 0.40ms^{-1} . Calculate, using your answer to (b)(i), the wavelength of the wave.
 - The wave travels into another medium M_2 . The refractive index of M_2 relative to M_1 is 1.8. Calculate the wavelength of the wave in M_2 .
- d. Outline, with reference to the graph and to Ohm's law, whether or not each component is ohmic. [3]
- e. Components X and Y are connected in parallel. The parallel combination is then connected in series with a variable resistor R and a cell of emf 8.0V and negligible internal resistance. [8]

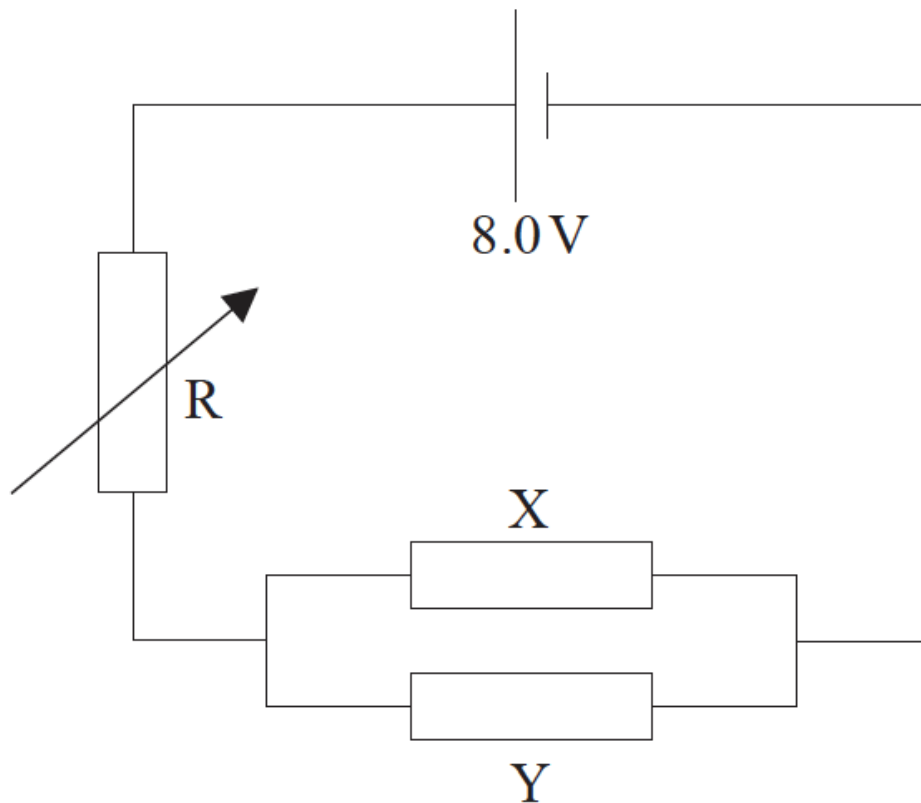

The resistance of R is adjusted until the currents in X and Y are equal.

- (i) Using the graph, calculate the resistance of the parallel combination of X and Y.
- (ii) Using your answer to (e)(i), determine the resistance of R.
- (iii) Determine the power delivered by the cell to the circuit.

Markscheme

- a. the acceleration (of a particle/P) is (directly) proportional to displacement;
and is directed towards equilibrium/in the opposite direction to displacement;
Do not accept "directed towards the centre".

- b. (i) 0.30 s;

(ii) max velocity = $0.74 (\pm 0.02) \text{ ms}^{-1}$;
recognize max velocity = ωx_0 ;
 $\omega = \left(\frac{2\pi}{T} = \frac{2\pi}{0.30} = \right) 20.9 \text{ rads}^{-1}$;
 $x_0 = \left(\frac{0.74}{20.9} = \right) 3.5 (\pm 2.0) \times 10^{-2} \text{ m}$;

or

identifies displacement with area;
uses one quarter of a cycle;
answer in the range of 30 to 40 mm;
answer in the range of 33 to 37 mm;

(iii) $v = 0.64 (\pm 2.0) \text{ ms}^{-1}$;
use $v = \omega \sqrt{(x_0^2 - x^2)}$ to get $x = 1.7 (\pm 0.2) \times 10^{-2} \text{ m}$

or

recognition that $x = x_0 \cos \omega t$;
 $x = \left(= 35 \cos \left[\frac{2\pi}{0.3} \times 0.2 \right] \right) = 17.5 \text{ mm}$;

c. (i) the direction of energy propagation is at right angles to the motion of the particles/atoms/molecules in the medium;

$$\lambda = \frac{v}{f} = vT;$$

(ii) $= (0.40 \times 0.3) = 0.12\text{m};$

(iii) $n/1.8 = \frac{v_1}{v_2} = \frac{\lambda_1}{\lambda_2};$
to give $\lambda_2=0.067\text{m};$

d. X: graph is a straight line and through the origin / resistance is constant;

so because $V \propto I$ it is ohmic;

Y: not ohmic because graph is not straight/is curved / resistance is not constant;
Award [3] for an answer where resistance values are calculated to show constancy or otherwise.

e. (i) read-off of intersection of lines X and Y [4.0,6.0] / reference to 4.0V **and** 6.0mA; { (allow power of 10 error)

$$R_X = R_Y = \frac{6.0}{4.0 \times 10^{-3}} = 1.5 \times 10^3 \Omega;$$

resistance of combination=750Ω;

(ii) use the idea of potential divider $\frac{R}{750} = \frac{2.0}{6.0};$
 $R=250\Omega;$

or

current=8mA;

$$R = \frac{2.0}{0.008} = 250 (\Omega);$$

(iii) total resistance=1000Ω;
total current= $8.0 \times 10^{-3}\text{A}$ **or** pd=8.0V;
total power= $(8.0 \times 8.0 \times 10^{-3})=64\text{mW};$

Examiners report

- a. [N/A]
- b. [N/A]
- c. [N/A]
- d. [N/A]
- e. [N/A]

Part 2 Simple harmonic oscillations

A longitudinal wave travels through a medium from left to right.

Graph 1 shows the variation with time t of the displacement x of a particle P in the medium.

Graph 1

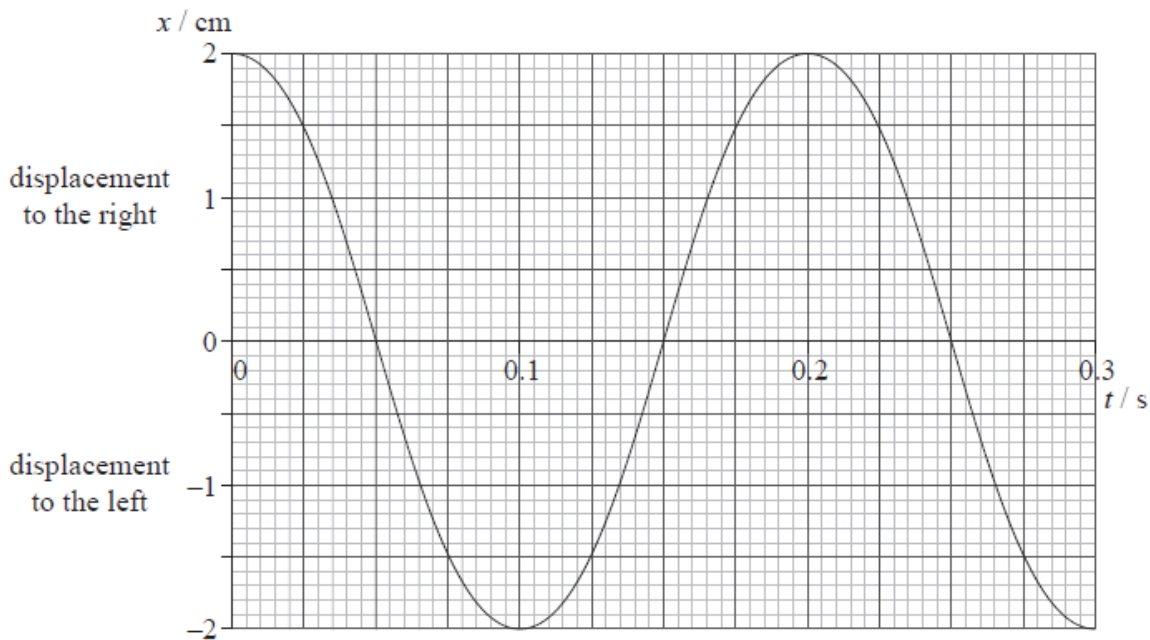

a. For particle P,

[6]

- (i) state how graph 1 shows that its oscillations are not damped.
- (ii) calculate the magnitude of its maximum acceleration.
- (iii) calculate its speed at $t=0.12$ s.
- (iv) state its direction of motion at $t=0.12$ s.

b. Graph 2 shows the variation with position d of the displacement x of particles in the medium at a particular instant of time.

[4]

Graph 2

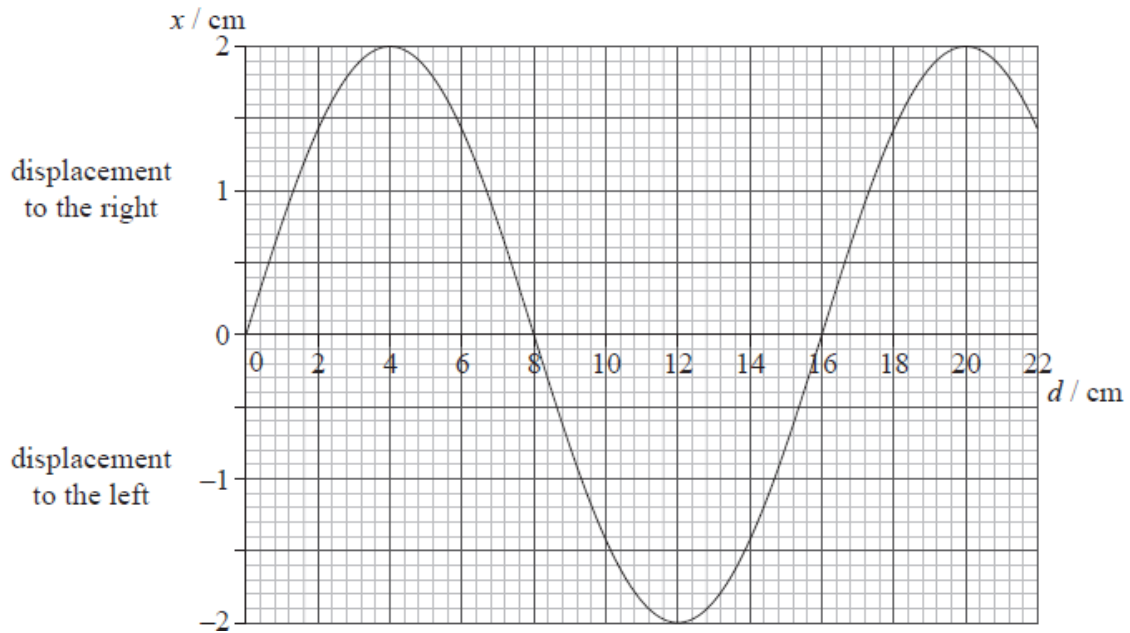

Determine for the longitudinal wave, using graph 1 and graph 2,

- (i) the frequency.
- (ii) the speed.

c. **Graph 2** – reproduced to assist with answering (c)(i).

[4]

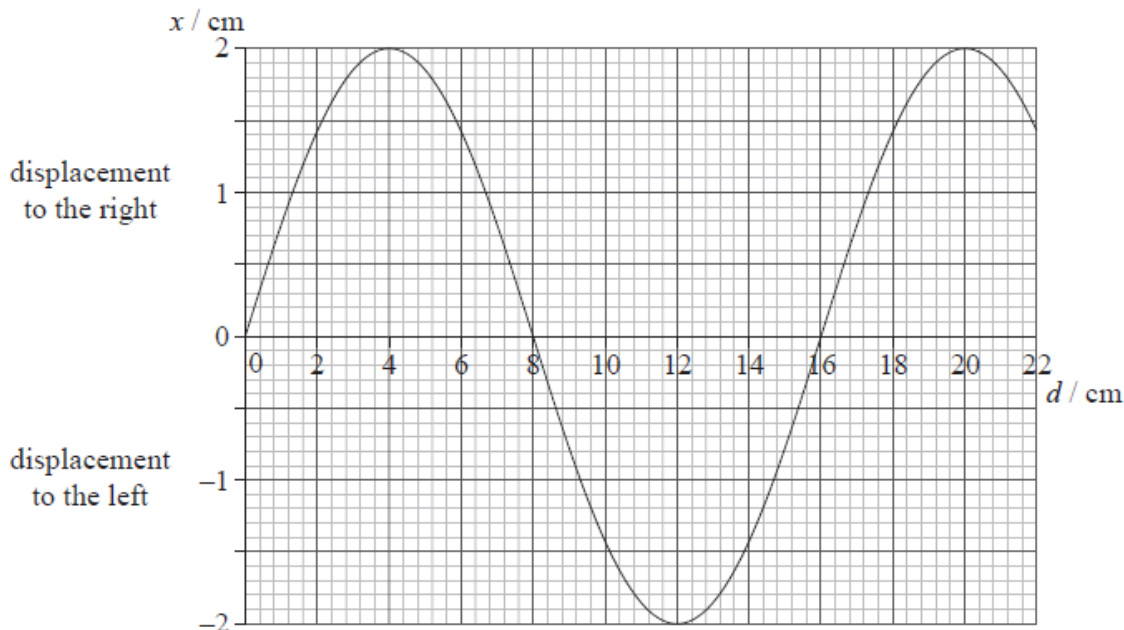

(c) The diagram shows the equilibrium positions of six particles in the medium.

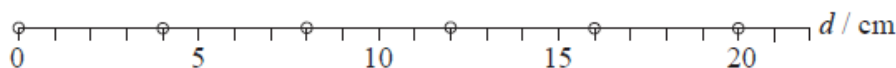

(i) On the diagram above, draw crosses to indicate the positions of these six particles at the instant of time when the displacement is given by graph 2.

(ii) On the diagram above, label with the letter C a particle that is at the centre of a compression.

Markscheme

a. (i) the amplitude is constant;

(ii) period is 0.20s;

$$a_{\max} = \left(\left[\frac{2\pi}{T} \right]^2 x_0 = 31.4^2 \times 2.0 \times 10^{-2} \right) = 19.7 \approx 20 \text{ms}^{-2}$$

Award [2] for correct bald answer and ignore any negative signs in answer.

(iii) displacement at $t = 0.12\text{cm}$ is $(-)$ 1.62cm;

$$v \left(= \frac{2\pi}{T} \sqrt{x_0 - x^2} \right) = 31.4 \sqrt{(2.0 \times 10^{-2})^2 - (1.62 \times 10^{-2})^2} = 0.37 \text{ms}^{-1};$$

Accept displacement in range 1.60 to 1.70 cm for an answer in range 0.33ms⁻¹ to 0.38ms⁻¹.

or

$$v_0 = \frac{2\pi}{T} x_0 = 0.628 \text{ms}^{-1};$$

$$|v| = \left(\left| -v_0 \sin \left[\frac{2\pi}{T} t \right] \right| \Rightarrow |v| = \left| -0.628 \sin [31.4 \times 0.12] \right| = \left| 0.37 \right| \right) = 0.37 \text{ms}^{-1};$$

or

drawing a tangent at 0.12s;

measurement of slope of tangent;

Accept answer in range 0.33ms⁻¹ to 0.38ms⁻¹.

b. (i) use of $f = \frac{1}{T}$;

$$\text{and so } f \left(= \frac{1}{0.20} \right) = 5.0 \text{Hz};$$

(ii) wavelength is 16cm;

and so speed is $v (= f\lambda = 5.0 \times 0.16) = 0.80 \text{ms}^{-1}$;

c. (i) points at 0, 8 and 16 cm stay in the same place;

points at 4 and 20 cm move 2 cm to the right;

point at 12 cm moves 2 cm to the left;



(ii) the point at 8 cm;

Examiners report

- a. [N/A]
- b. [N/A]
- c. [N/A]

This question is in **two** parts. **Part 1** is about wave motion. **Part 2** is about renewable energy sources.

Part 1 Wave motion

The diagram shows a wave that is travelling to the right along a stretched string at a particular instant.

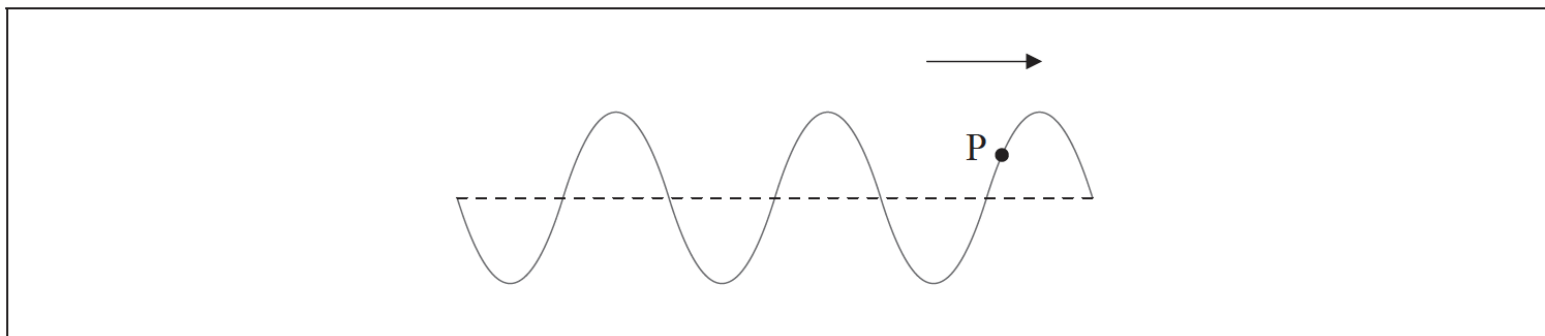

The dotted line shows the position of the stretched string when it is undisturbed. P is a small marker attached to the string.

- a. On the diagram above, identify [2]
 - (i) with an arrow, the direction of movement of marker P at the instant in time shown.
 - (ii) the wavelength of the wave.
- b. The wavelength of the wave is 25mm and its speed is 18mms⁻¹. [2]
 - (i) Calculate the time period T of the oscillation of the wave.
 - (ii) On the diagram above, draw the displacement of the string at a time $\frac{T}{3}$ later than that shown in the diagram.
- c. Marker P undergoes simple harmonic motion. The amplitude of the wave is 1.7×10^{-2} m and the mass of marker P is 3.5×10^{-3} kg. [5]
 - (i) Calculate the maximum kinetic energy of marker P.
 - (ii) Sketch a graph to show how the kinetic energy E_K of marker P varies with time t from $t=0$ to $t=T$, where T is the time period of the oscillation calculated in (b). Annotate the axes of the graph with numerical values.

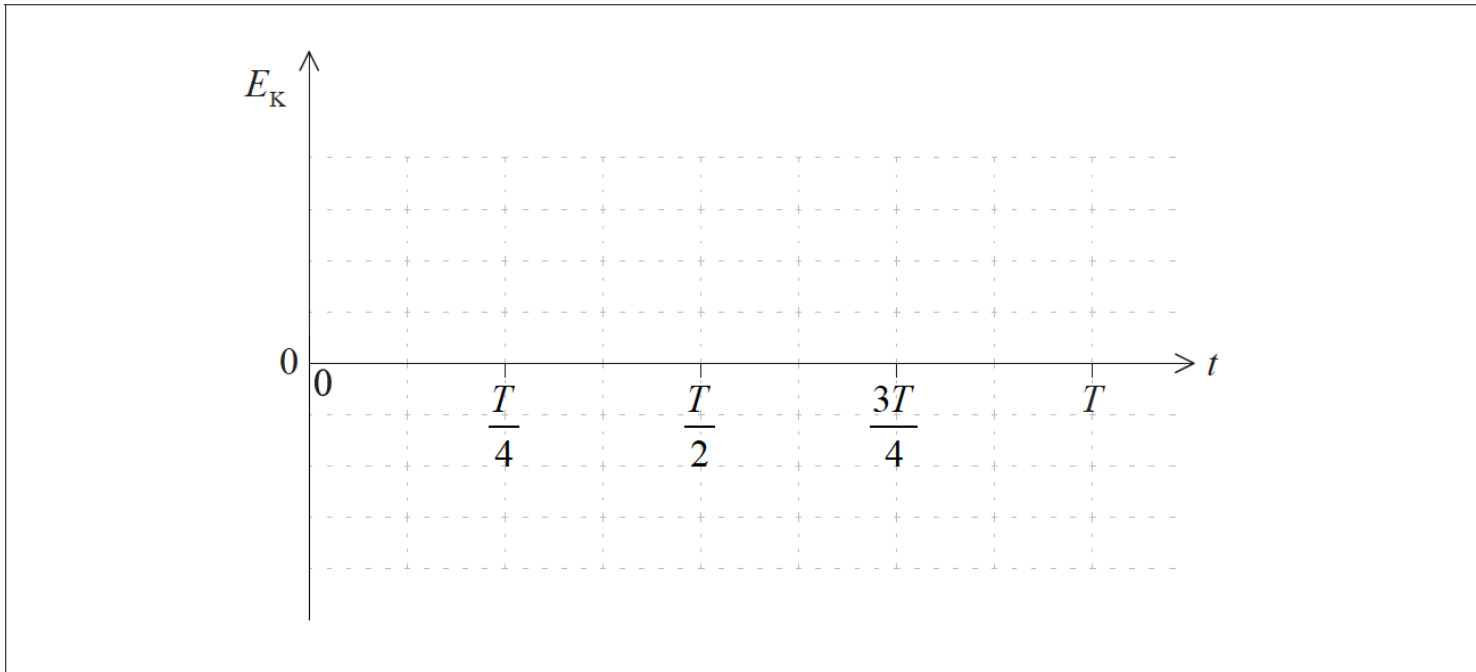

- d. The right-hand edge of the wave AB reaches a point where the string is securely attached to a second string in which the speed of waves is smaller than that of the first string. [5]
smaller than that of the first string.

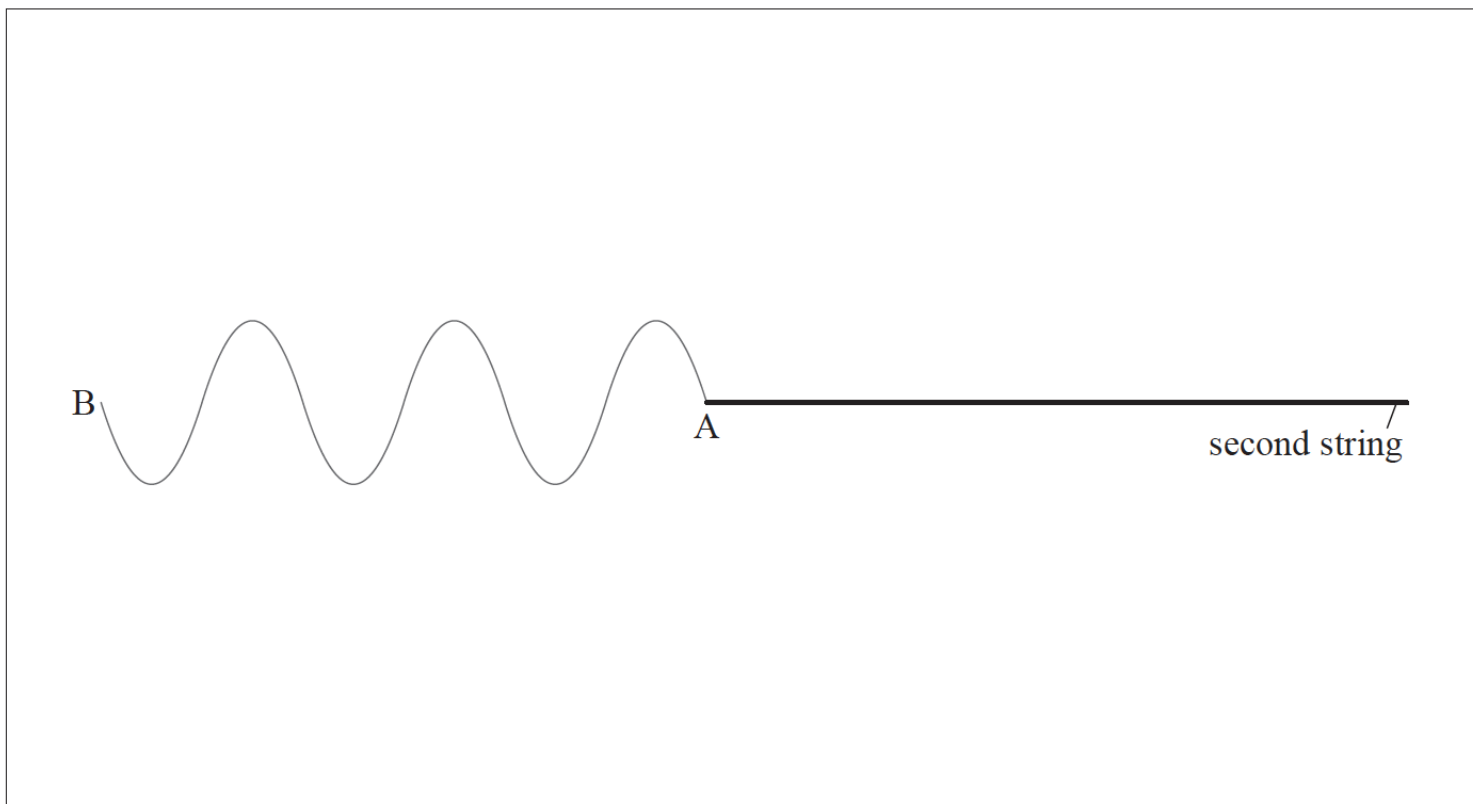

- (i) On the diagram above, draw the shape of the second string after the complete wave AB is travelling in it.
(ii) Explain the shape you have drawn in your answer to (d)(i).

Markscheme

- a. (i) downward arrow at P;
(ii) clear single wavelength marked;

b. (i) frequency = $\frac{18}{25}$ (Hz) = 0.72 (Hz);

period = $\left(\frac{1}{0.72}\right) = 1.4$ s;

Award [2] for a bald correct answer.

(ii) wave moved to right by one-third of a cycle by eye;

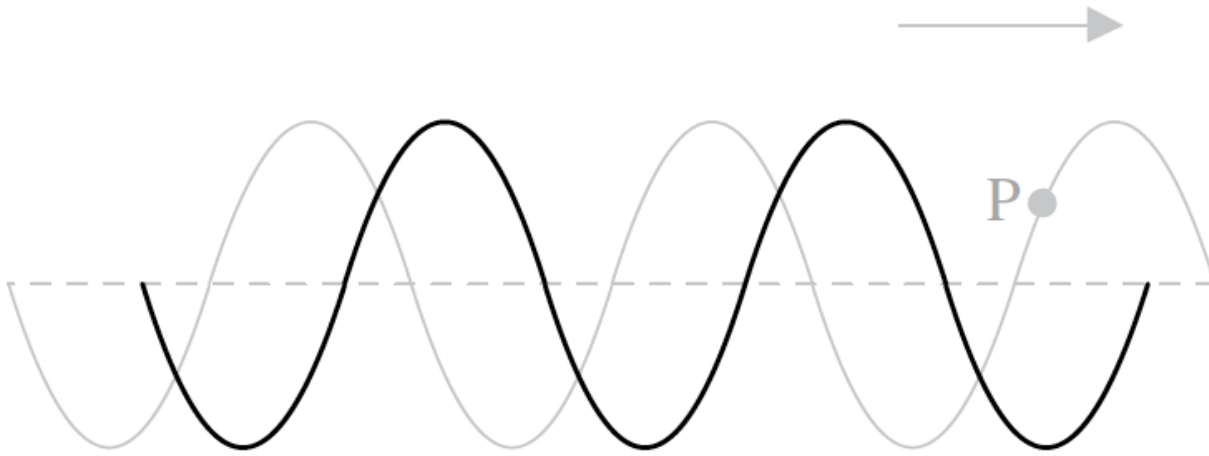

c. (i) $\omega = \frac{2\pi}{1.4}$;

$\left(\frac{1}{2} \times 3.5 \times 10^{-3} \times \left[\frac{4\pi^2}{1.4^2}\right] \times [1.7 \times 10^{-2}]^2\right) = 1.0 \times 10^{-5}$ J;

Award [2] for a bald correct answer.

(ii)

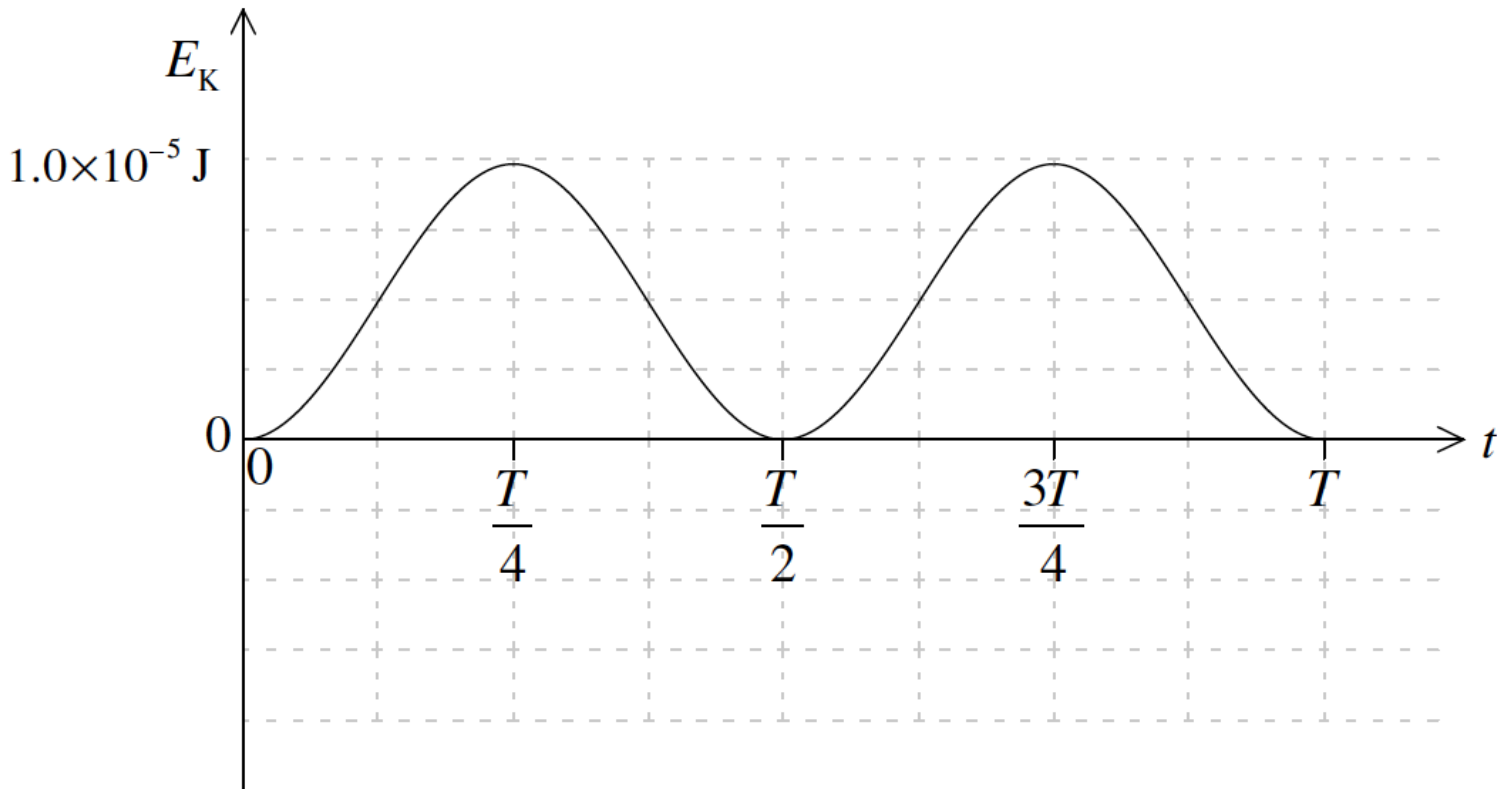

correct shape (\sin^2); (allow any phase for this graph)

varying between 0 and 1.0×10^{-5} J; { (allow ECF from (c)(i) but do not allow E to be negative)

one period takes $\frac{T}{2}$;

d. (i) reduced wavelength;

reduced amplitude;

(ii) speed reduced and frequency constant;

therefore wavelength reduced;

some energy reflected at boundary / second string is denser/greater mass per unit length;

therefore amplitude reduced;

Examiners report

a. [N/A]

b. [N/A]

c. [N/A]

d. [N/A]

This question is in **two** parts. **Part 1** is about wave motion. **Part 2** is about the melting of the Pobeda ice island.

Part 1 Wave motion

a. State what is meant by the terms ray and wavefront and state the relationship between them. [3]

b. The diagram shows three wavefronts, A, B and C, of a wave at a particular instant in time incident on a boundary between media X and Y. [4]

Wavefront B is also shown in medium Y.

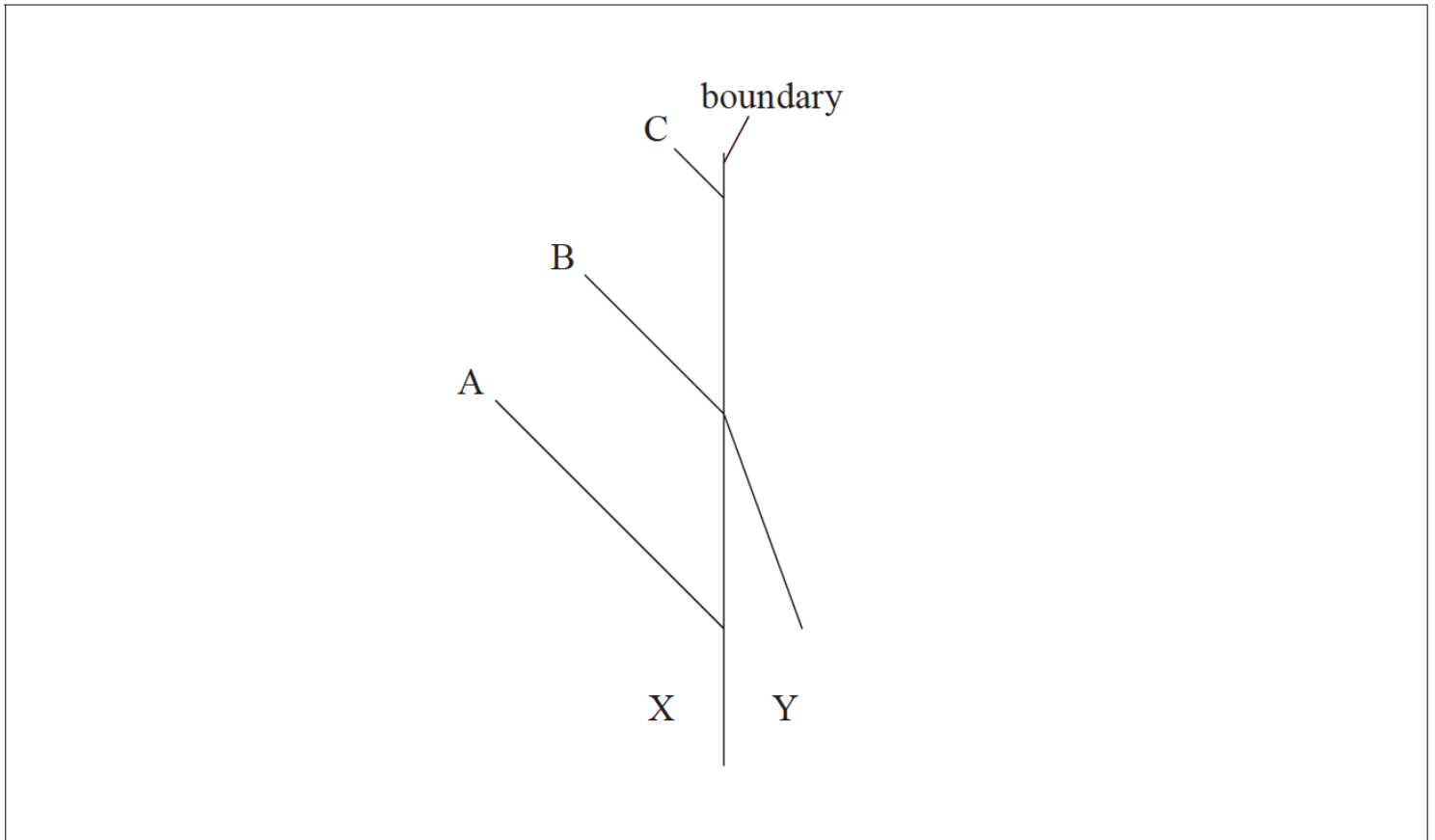

(i) Draw a line to show wavefront C in medium Y.

(ii) The refractive index of X is n_X and the refractive index of Y is n_Y . By making appropriate measurements, calculate $\frac{n_X}{n_Y}$.

c. Describe the difference between transverse waves and longitudinal waves.

[2]

d. The graph below shows the variation of the velocity v with time t for one oscillating particle of a medium.

[3]

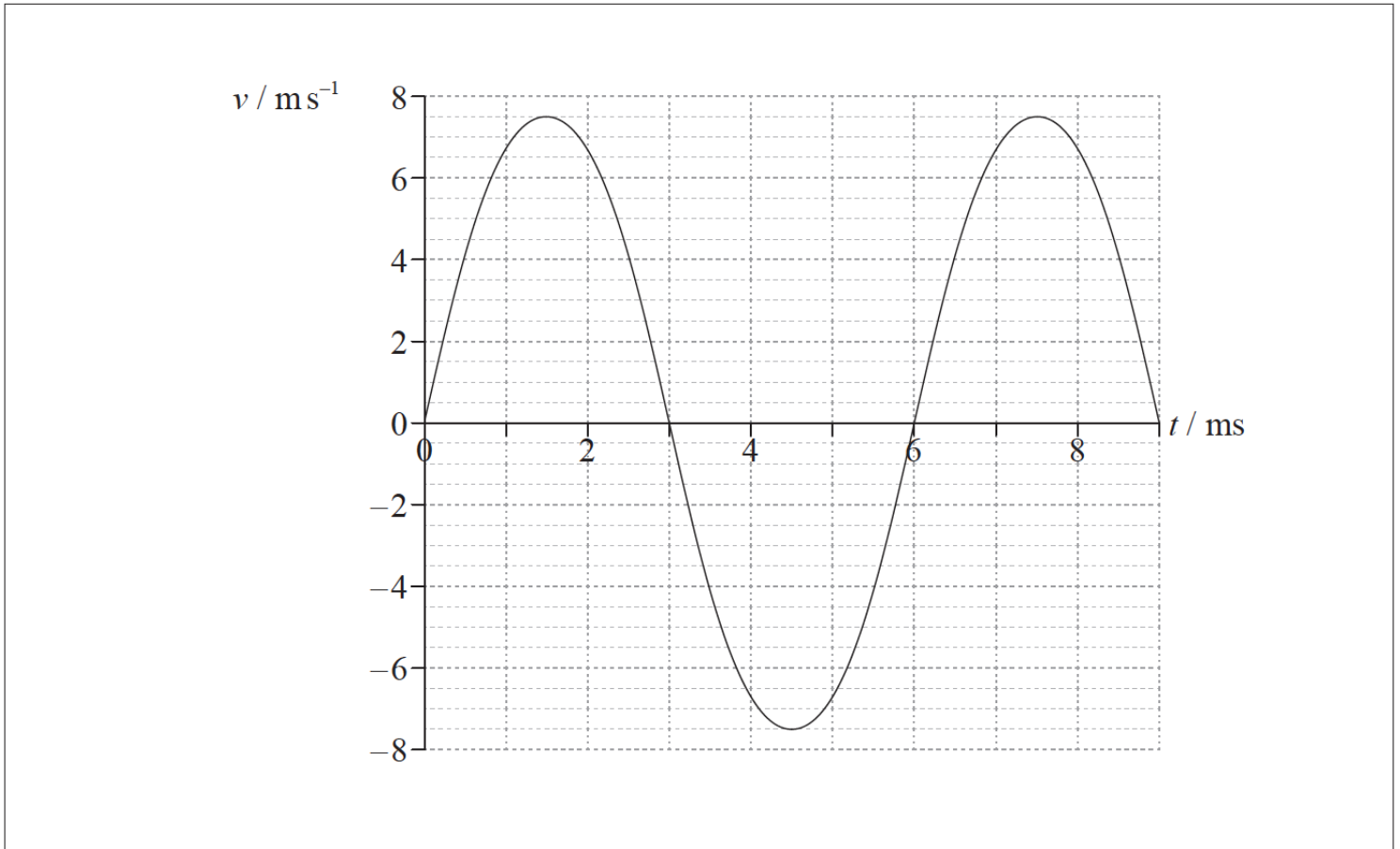

(i) Calculate the frequency of oscillation of the particle.

(ii) Identify on the graph, with the letter M, a time at which the displacement of the particle is a maximum.

Markscheme

a. ray: direction of wave travel / energy propagation;

wavefront: line that joins points with same phase/of same crest/trough;

ray normal/at right angles/perpendicular to wavefront;

b. (i) line parallel to existing line in Y and continuous at boundary; (both needed)

(ii) measures "wavelength" correctly in media X and Y; } (by eye)

(look for ratio of 0.5: 1 in responses)

$$\frac{n_X}{n_Y} = \frac{\lambda_Y}{\lambda_X};$$

0.5:1; (accept answers in the range of 0.47 to 0.53)

or

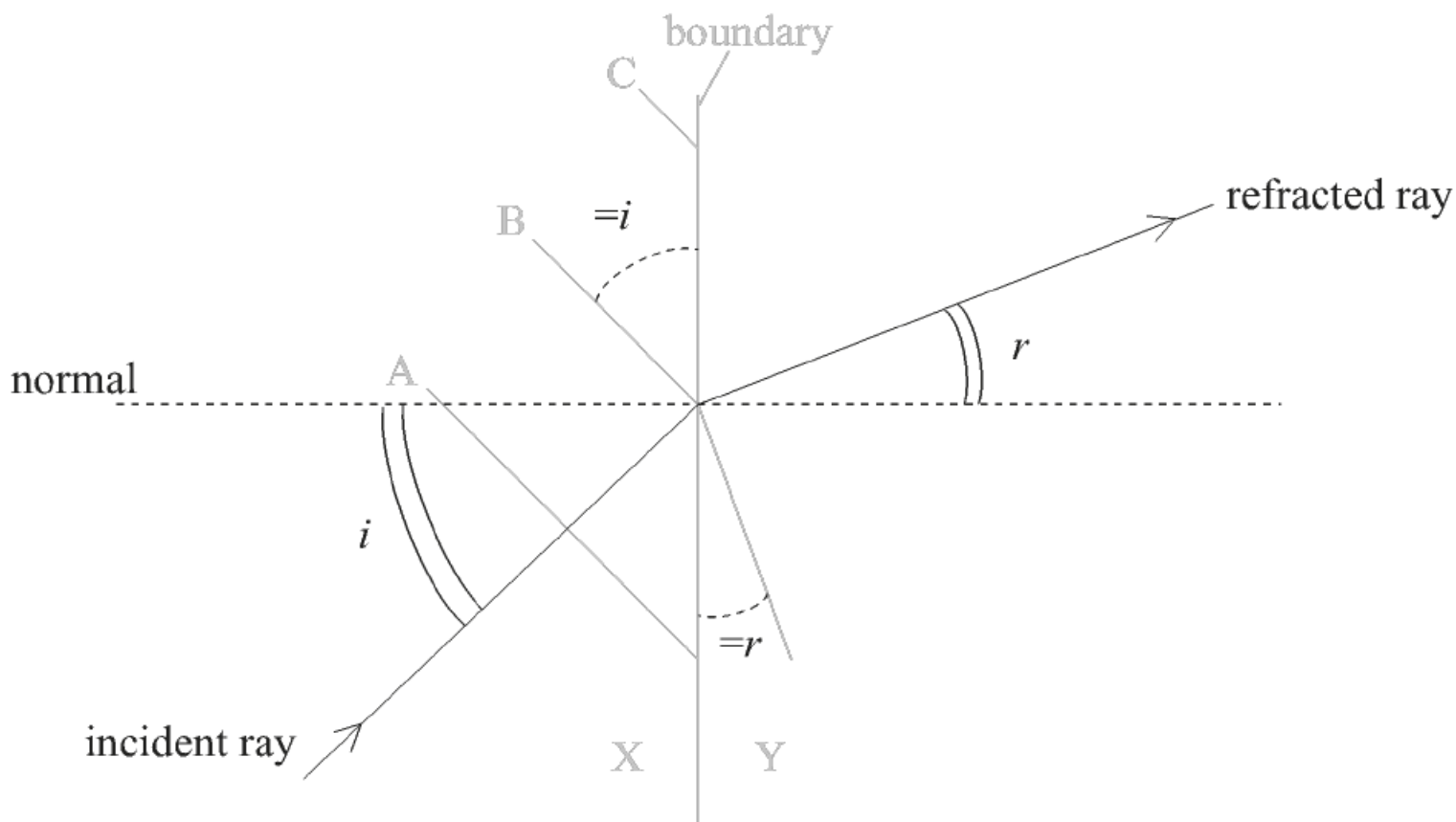

justification that angles needed for calculation are either pair of i and r as shown and angles measured correctly;

$$\frac{n_X}{n_Y} = \frac{\sin r}{\sin i};$$

0.5:1;

c. mention of perpendicular/right angle/90° angle for transverse and parallel for longitudinal;

clear comparison between direction of energy propagation and direction of vibration/oscillation of particles for both waves;

d. (i) time period=6.0ms;

167Hz;

(ii) M where line crosses x-axis;

(iii) counts rectangles (14±2) to first peak;

one rectangle equivalent to 0.5 mm;

7.2 mm;

or

$$\omega = (2\pi f =) 330\pi;$$

$$a = \left(\frac{v}{\omega} =\right) \frac{7.5}{330\pi};$$

7.2 mm;

Allow any valid algebraic method, eg $v = \omega \sqrt{(x_0^2 - x^2)}$.

Examiners report

a. [N/A]

b. [N/A]

c. [N/A]

d. [N/A]

This question is in **two** parts. **Part 1** is about simple harmonic motion (SHM) and a wave in a string. **Part 2** is about the unified atomic mass unit and a nuclear reaction.

Part 1 Simple harmonic motion and a wave in a string

- a. By reference to simple harmonic motion, state what is meant by amplitude. [1]
 b. A liquid is contained in a U-tube. [5]

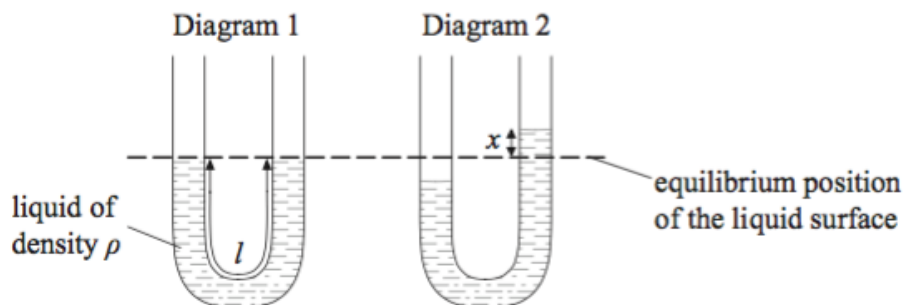

The pressure on the liquid in one side of the tube is increased so that the liquid is displaced as shown in diagram 2. When the pressure is suddenly released the liquid oscillates. The damping of the oscillations is small.

- (i) Describe what is meant by damping.
 (ii) The displacement of the liquid surface from its equilibrium position is x . The acceleration a of the liquid in the tube is given by the expression

$$a = -\frac{2g}{l}x$$

where g is the acceleration of free fall and l is the total length of the liquid column. The total length of the liquid column in the tube is 0.32m. Determine the period of oscillation.

- c. A wave is travelling along a string. The string can be modelled as a single line of particles and each particle executes simple harmonic motion. [9]

The period of oscillation of the particles is 0.80s.

The graph shows the displacement y of part of the string at time $t=0$. The distance along the string is d .

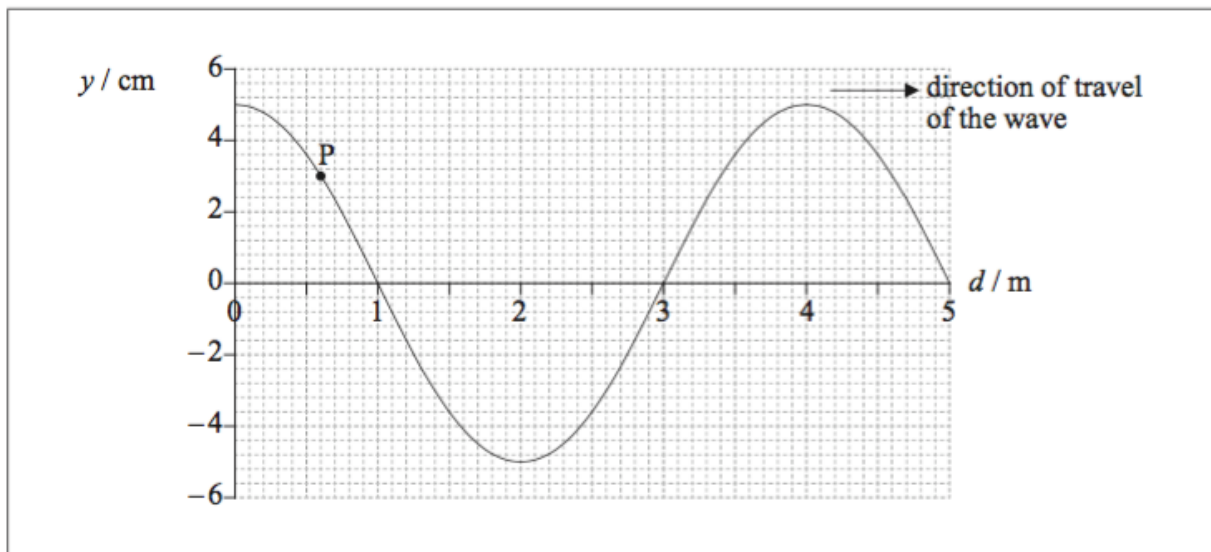

- (i) On the graph, draw an arrow to show the direction of motion of particle P at the point marked on the string.
 (ii) Determine the magnitude of the velocity of particle P.
 (iii) Show that the speed of the wave is 5.0 ms^{-1} .

(iv) On the graph opposite, label with the letter X the position of particle P at $t=0.40$ s.

Markscheme

a. the maximum displacement of the system from equilibrium/from centre of motion / *OWTTE*;

b. (i) the amplitude of the oscillations/(total) energy decreases (with time); because a force always opposes direction of motion/there is a resistive force/ there is a friction force;

Do not allow bald "friction".

$$(ii) \omega = \sqrt{\frac{2g}{l}};$$

$$T = 2\pi\sqrt{\frac{0.32}{2 \times 9.81}};$$

$$=0.80\text{s};$$

c. (i) upwards;

$$(ii) y_0 = 0.050(\text{m}) \text{ and } y = 0.030(\text{m});$$

$$\omega = \left(\frac{2\pi}{0.80}\right) = 7.85 \text{ (rads}^{-1}\text{)};$$

$$v = 7.85\sqrt{[0.05]^2 - [0.03]^2};$$

$$=0.31\text{ms}^{-1}; \text{ (allow working in cm to give } 31 \text{ cms}^{-1}\text{)};$$

$$(iii) \lambda=4.0\text{m};$$

$$\text{recognition that } f = \frac{1}{0.80} (= 1.25);$$

$$(f\lambda)v=1.25 \times 4.0;$$

$$(=5.0 \text{ ms}^{-1})$$

$$(iv) y=-3.0 \text{ cm, } d=0.6 \text{ m};$$

Examiners report

a.
b.
c.

This question is in **two** parts. **Part 1** is about simple harmonic motion and the superposition of waves. **Part 2** is about gravitational fields.

Part 1 Simple harmonic motion and the superposition of waves

An object of mass m is placed on a frictionless surface and attached to a light horizontal spring. The other end of the spring is fixed.

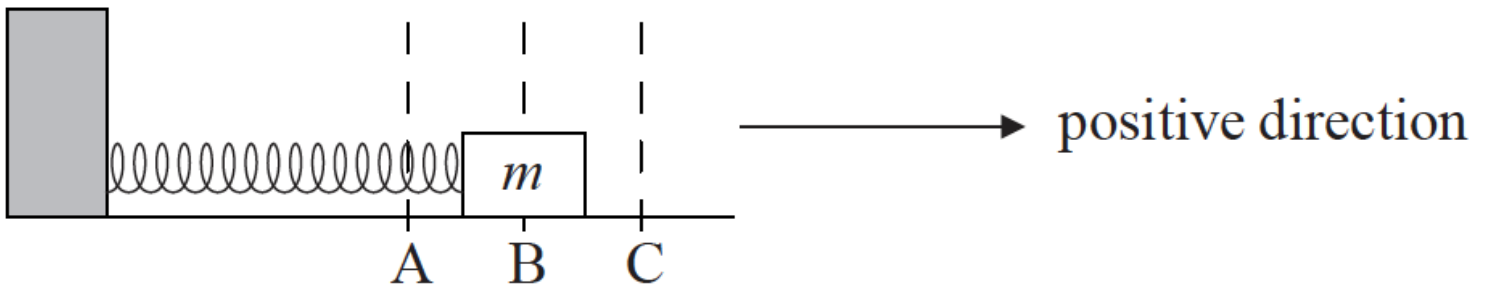

The equilibrium position is at B. The direction B to C is taken to be positive. The object is released from position A and executes simple harmonic motion between positions A and C.

a. Define *simple harmonic motion*.

[2]

b. (i) On the axes below, sketch a graph to show how the acceleration of the mass varies with displacement from the equilibrium position B.

[3]

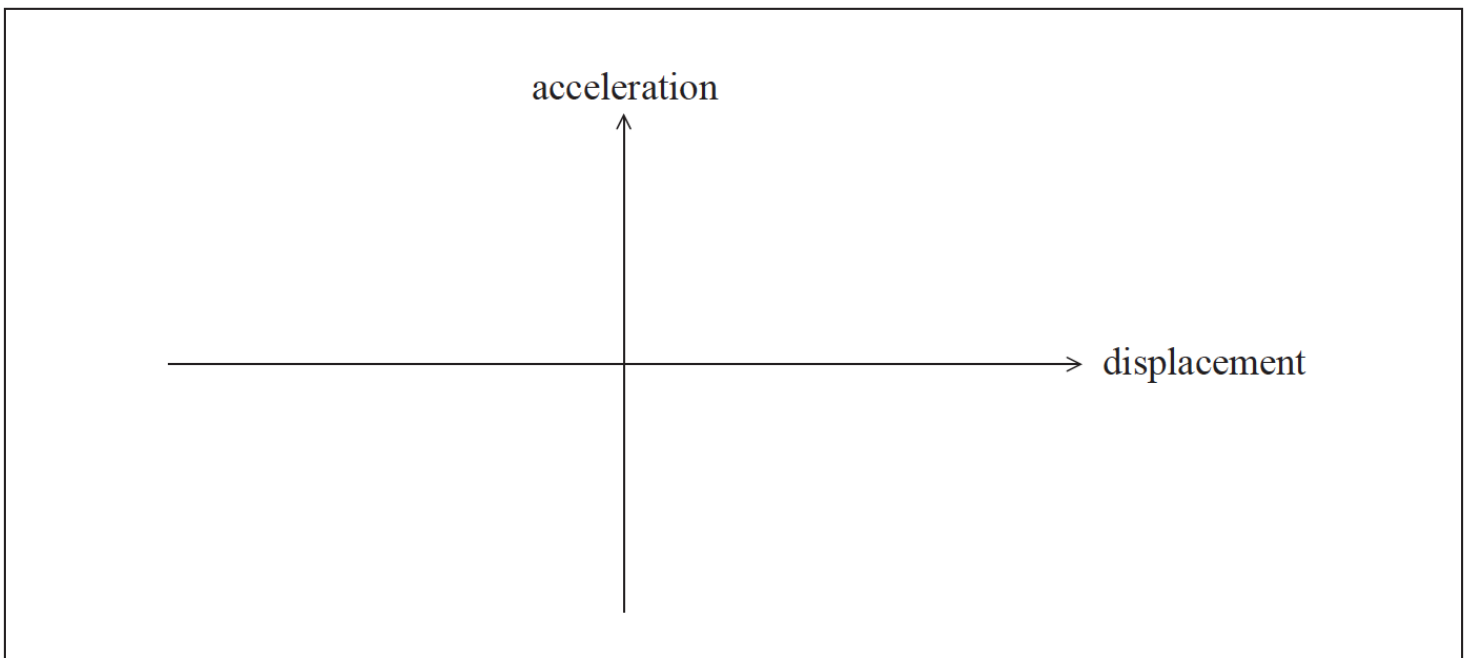

(ii) On your graph, label the points that correspond to the positions A, B and C.

c. (i) On the axes below, sketch a graph to show how the velocity of the mass varies with

[3]

time from the moment of release from A until the mass returns to A for the first time.



(ii) On your graph, label the points that correspond to the positions A, B and C.

d. The period of oscillation is 0.20s and the distance from A to B is 0.040m. Determine the maximum speed of the mass. [3]

e. A long spring is stretched so that it has a length of 10.0 m. Both ends are made to oscillate with simple harmonic motion so that transverse waves of equal amplitude but different frequency are generated. [4]

Wave X, travelling from left to right, has wavelength 2.0 m, and wave Y, travelling from right to left, has wavelength 4.0 m. Both waves move along the spring at speed 10.0 m s^{-1} .

The diagram below shows the waves at an instant in time.

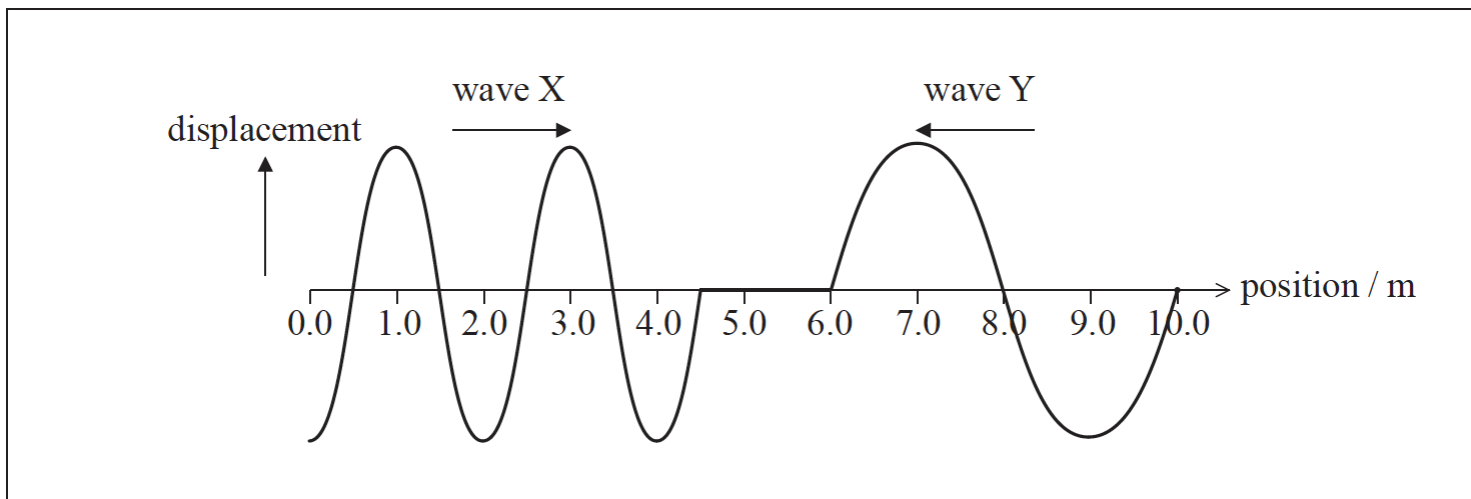

(i) State the principle of superposition as applied to waves.

(ii) By drawing on the diagram or otherwise, calculate the position at which the resultant wave will have maximum displacement 0.20 s later.

Markscheme

a. the force/acceleration is proportional to the displacement from the equilibrium position/centre;

the force/acceleration is directed towards the equilibrium position/centre / the force/acceleration is in the opposite direction to the displacement;

- b. (i) straight line through the origin;
with negative gradient;

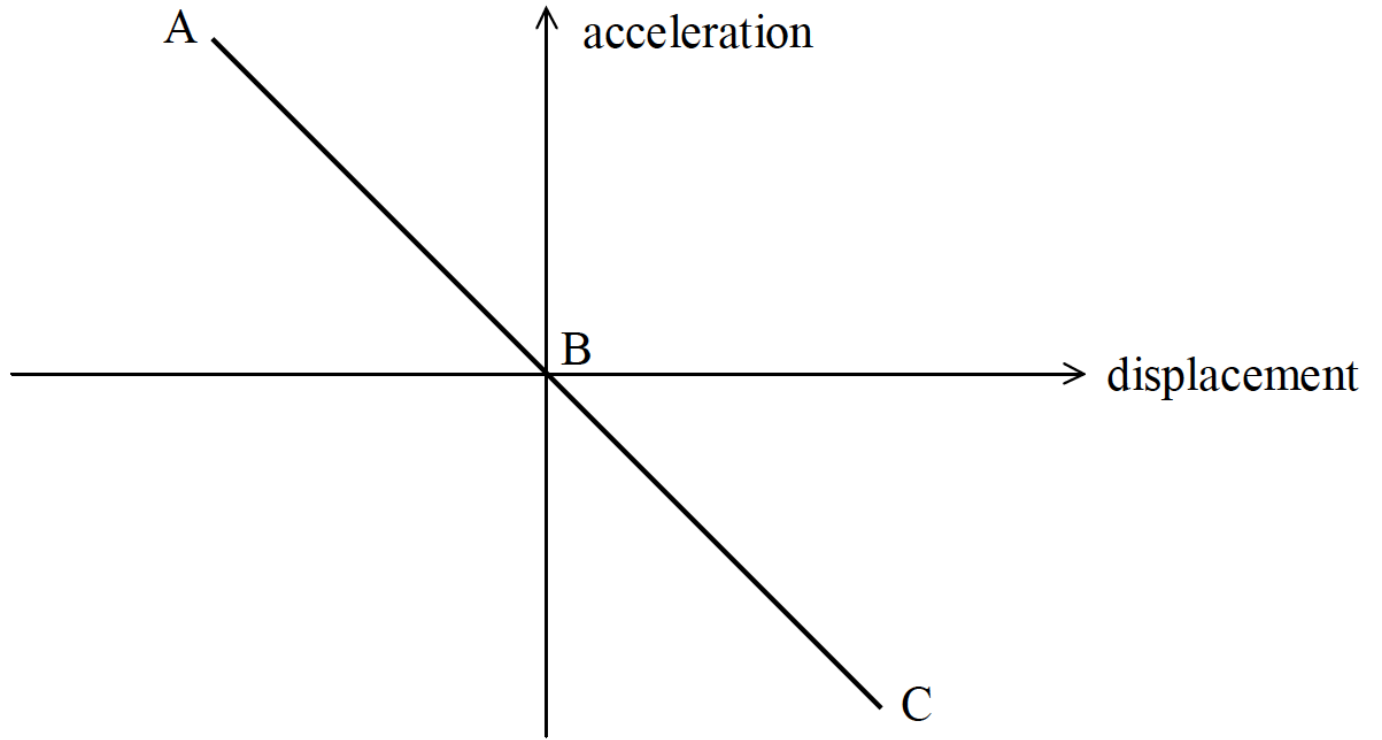

- (ii) all three labels correct;

- c. (i) positive sine graph;
drawn correctly for one period;

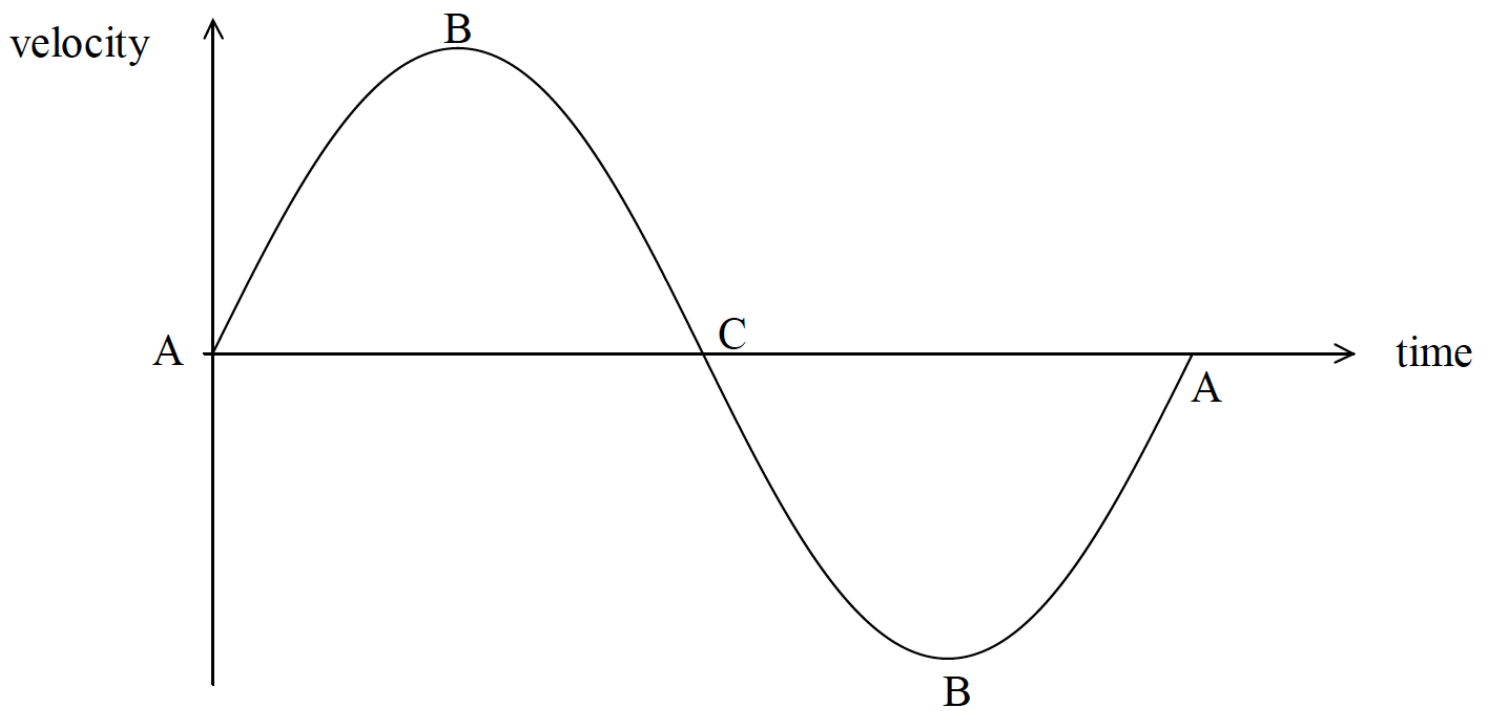

(ii) all three labels correct;

Accept either of the As and either of the Bs.

Accept either B if shown on the time axis in the correct position.

d. $\omega = \frac{2\pi}{T} = \frac{2\pi}{0.20} = 31.42 \approx 31 \text{rads}^{-1}$;

$$v_{\max} = \omega x_0 = 31.42 \times 0.040;$$

$$v_{\max} = 1.257 \approx 1.3 \text{ms}^{-1};$$

e. (i) if two or more waves overlap/meet/pass through the same point;

the resultant displacement at any point is found by adding the displacements produced by each individual wave;

(ii) 0.20 s later, wave X will have crests at 5.0, 3.0 and 1.0 m, wave Y will have crests at 5.0 and 9.0 m / each wave will have moved forward by 2.0 m in 0.20 s / wave profiles for 0.20 s later drawn on diagram;

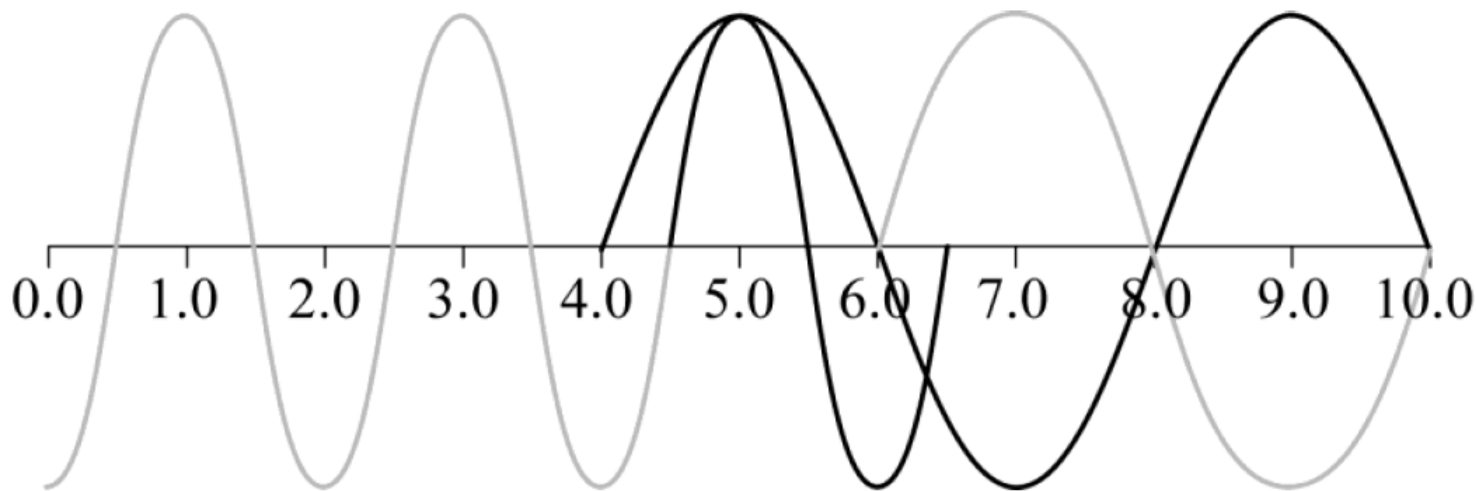

maximum displacement where two crests meet, *i.e.* at 5.0 m;

Examiners report

- a. [N/A]
- b. [N/A]
- c. [N/A]
- d. [N/A]
- e. [N/A]

Part 2 Simple harmonic motion and waves

a. One end of a light spring is attached to a rigid horizontal support.

[8]

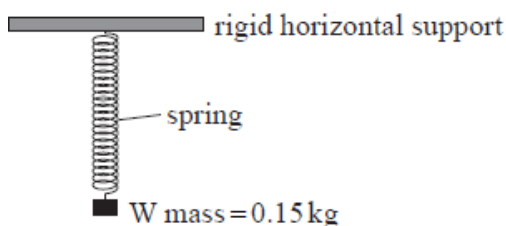

An object W of mass 0.15 kg is suspended from the other end of the spring. The extension x of the spring is proportional to the force F causing the extension. The force per unit extension of the spring k is 18Nm^{-1} .

A student pulls W down such that the extension of the spring increases by 0.040 m. The student releases W and as a result W performs simple harmonic motion (SHM).

- (i) State what is meant by the expression “W performs SHM”.
- (ii) Determine the maximum acceleration of W.
- (iii) Determine the period of oscillation of the spring.
- (iv) Determine the maximum kinetic energy of W.

c. A light spring is stretched horizontally and a longitudinal travelling wave is set up in the spring, travelling to the right. [6]

- (i) Describe, in terms of the propagation of energy, what is meant by a longitudinal travelling wave.
- (ii) The graph shows how the displacement x of one coil C of the spring varies with time t .

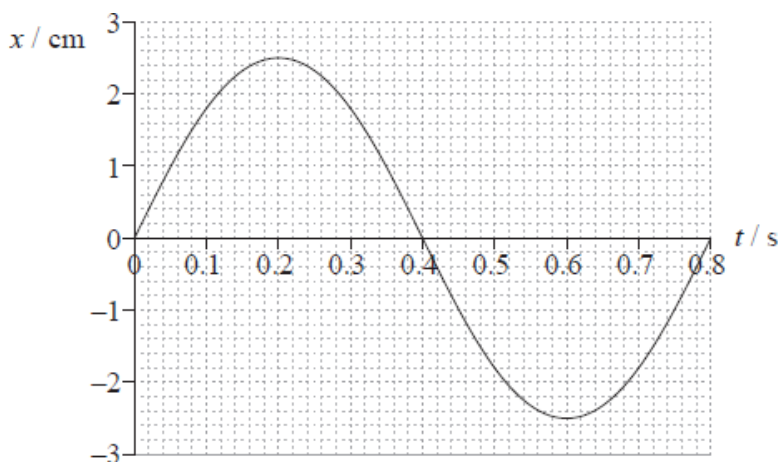

The speed of the wave is 3.0 cms^{-1} . Determine the wavelength of the wave.

- (iii) Draw, on the graph in (c)(ii), the displacement of a coil of the spring that is 1.8 cm away from C in the direction of travel of the wave, explaining your answer.

Markscheme

a. (i) the acceleration of (force acting on) W is proportional to its displacement from equilibrium;

and directed towards equilibrium;

(ii) $F = (18 \times 0.04) = 0.72 \text{ N}$;
 acceleration = $\frac{0.72}{0.15} = 4.8 \text{ ms}^{-2}$;

(iii) $\omega = \sqrt{\frac{a}{x}}$;
 $= 10.95 \text{ rads}^{-2}$;
 $T = \left(\frac{2\pi}{\omega}\right) = \frac{6.28}{10.95} = 0.57 \text{ s}$;

(iv) $= 1.4 \times 10^{-2} \text{ (J)}$;

c. (i) the direction of oscillation of the particles of the medium;

(*must see “particles”*)

is in the direction of energy propagation;

Accept answer in terms of coils of spring in place of particles of medium.

(ii) frequency = $\left(\frac{1}{T} = \frac{1}{0.80} =\right) 1.25 \text{ Hz}$;

wavelength = $\frac{v}{f} = \frac{3.0}{1.25} = 2.4 \text{ cm or } 2.4 \times 10^{-2} \text{ m}$;

(iii)

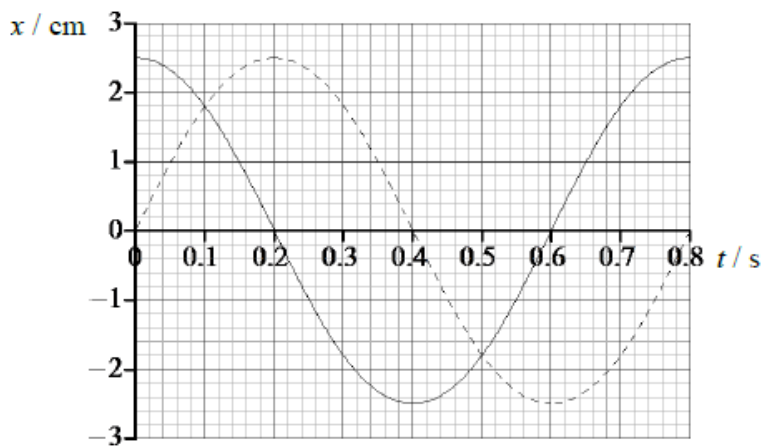

graph: positive cosine; (line must cross axis at 0.2 and 0.6 as shown)

explanation: 1.8 cm is $\frac{3}{4}$ of a wavelength;

Examiners report

- a. There were a few G2 comments suggesting that this question was off-syllabus as it involved (the G2s claimed) the use of Hooke's law. In fact, k was defined as force per unit extension rather than as the spring constant and the whole question was accessible through knowledge based purely on SHM theory.
- (i) Many realized that for two marks they were required to state the relationship between acceleration and displacement and give the direction of acceleration.
- (ii) and (iii) The determination of the maximum acceleration and the period of oscillation were well done by many at HL. A number of routes were possible for part (iii) and all gained equal credit. Answers were patchier from SL candidates who struggled more than the HL with these tasks.
- (iv) **SL only** Performance was again patchy. Some of the candidates at SL do not seem at ease with the ideas and equations that lie behind SHM theory.
- c. (i) Examiners were disappointed to see that candidates could only rarely give a complete description of a longitudinal travelling wave. Descriptions were vague and rarely made the relative directions of energy propagation and particle displacement clear in an unambiguous way.
- (ii) Although many obtained the correct answer, the method used was often unexplained with no obvious link to the graph via a statement of frequency or period. Such non-clarity was penalized.
- (iii) Most candidates were unable to make progress with this question and it was frequently left blank. The problem required a recognition that a distance of 1.8 cm corresponded to a $\frac{3}{4}\lambda$ shift and hence a corresponding shift on the graph.

Simple harmonic motion and forced oscillations

The graph shows the variation with time of the displacement of an object undergoing simple harmonic motion.

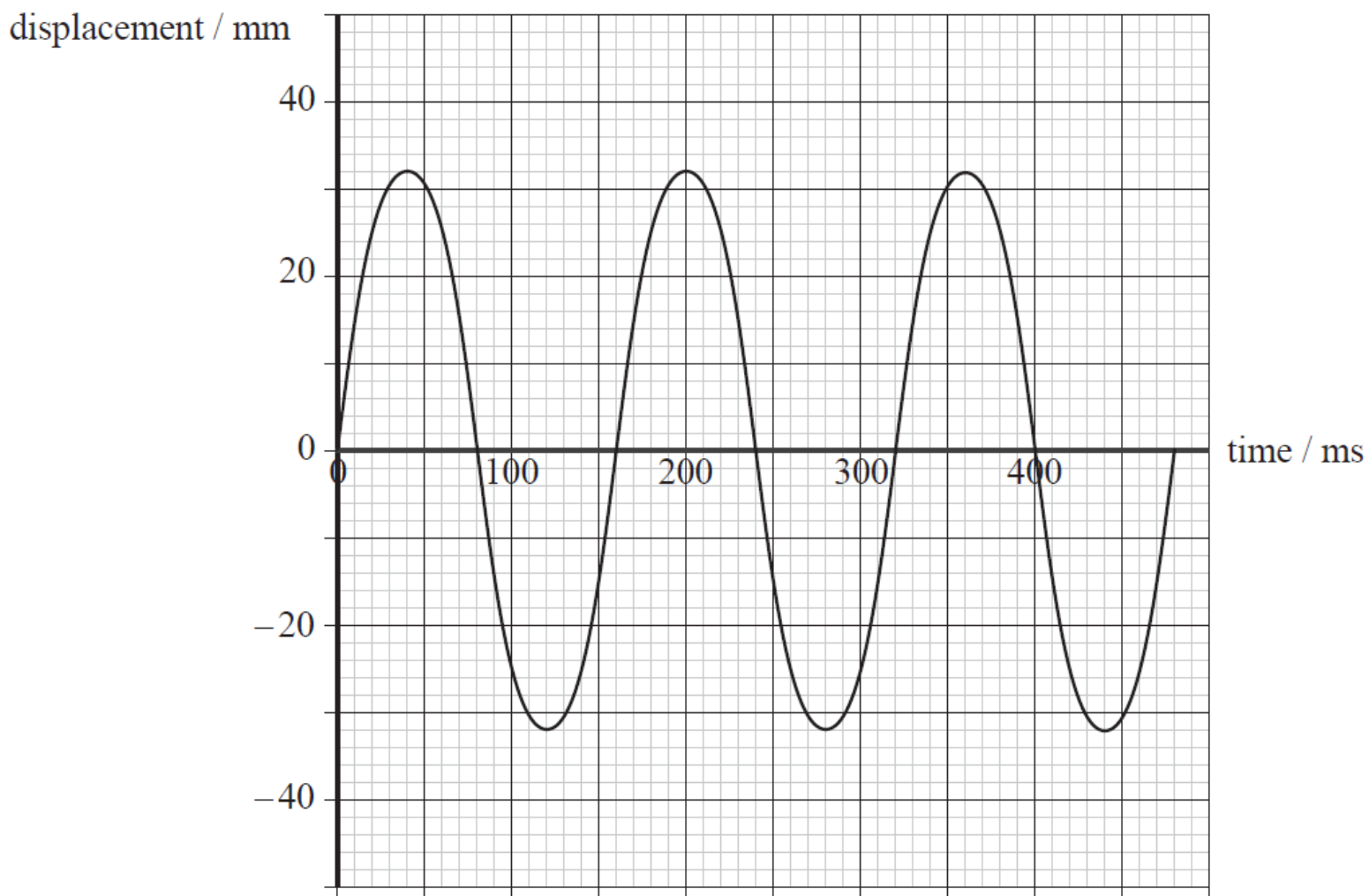

- a. (i) State the amplitude of the oscillation. [3]
- (ii) Calculate the frequency of the oscillation.
- b. (i) Determine the maximum speed of the object. [4]
- (ii) Determine the acceleration of the object at 140 ms.
- c. The graph below shows how the displacement of the object varies with time. Sketch on the same axes a line indicating how the kinetic energy [3]
of the object varies with time.
- You should ignore the actual values of the kinetic energy.

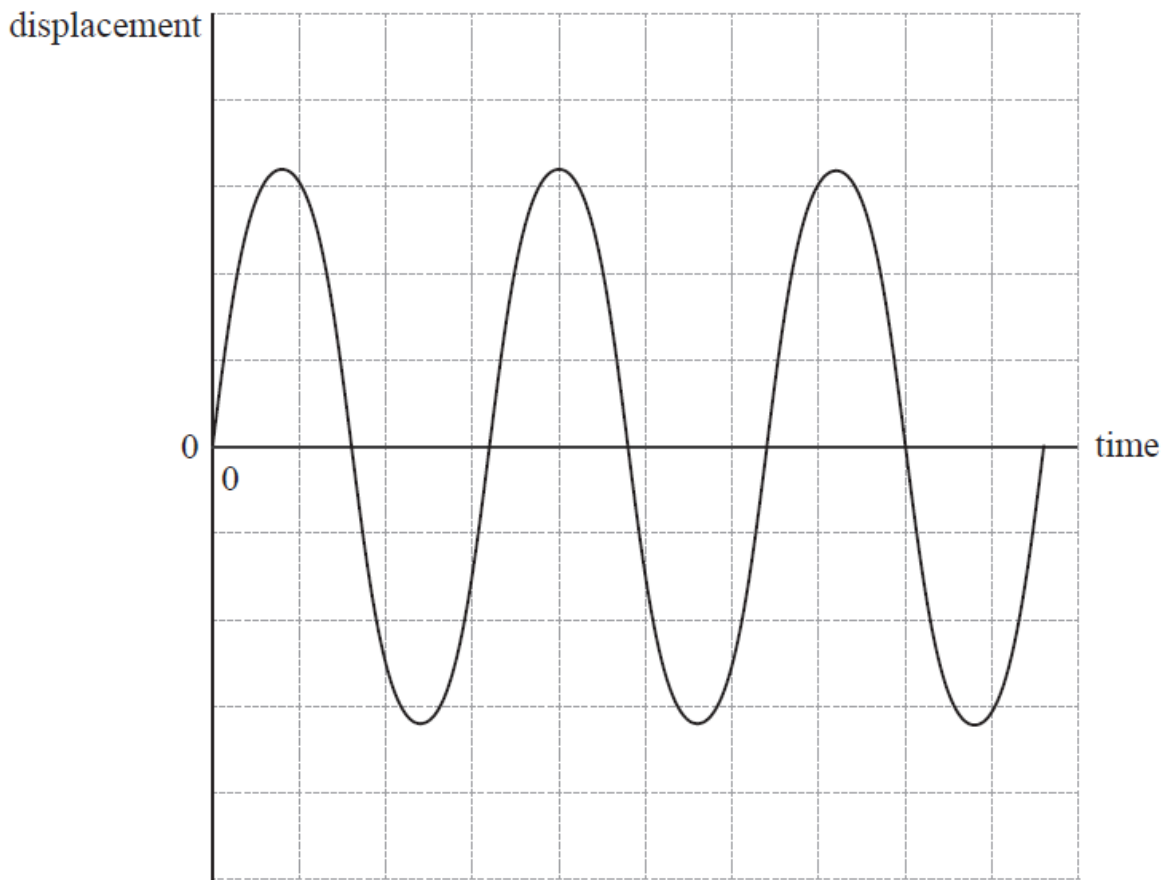

Markscheme

a. (i) 32 (mm);

(ii) period = 160 (ms);

frequency = $6.2/6.3$ (Hz);

Allow ECF for incorrect period.

b. (i) $\omega = 2\pi \times 6.25$;

$v = 39.3 \times 32 \times 10^{-3} = 1.3 (\text{ms}^{-1})$; *(allow ECF from (a))*

or

tangent drawn to graph at a point of zero displacement;

gradient calculated between 1.2 and 1.4;

(ii) displacement = 23–26 (mm);

35–40 (ms^{-2});

23 mm found by calculating displacement

c.

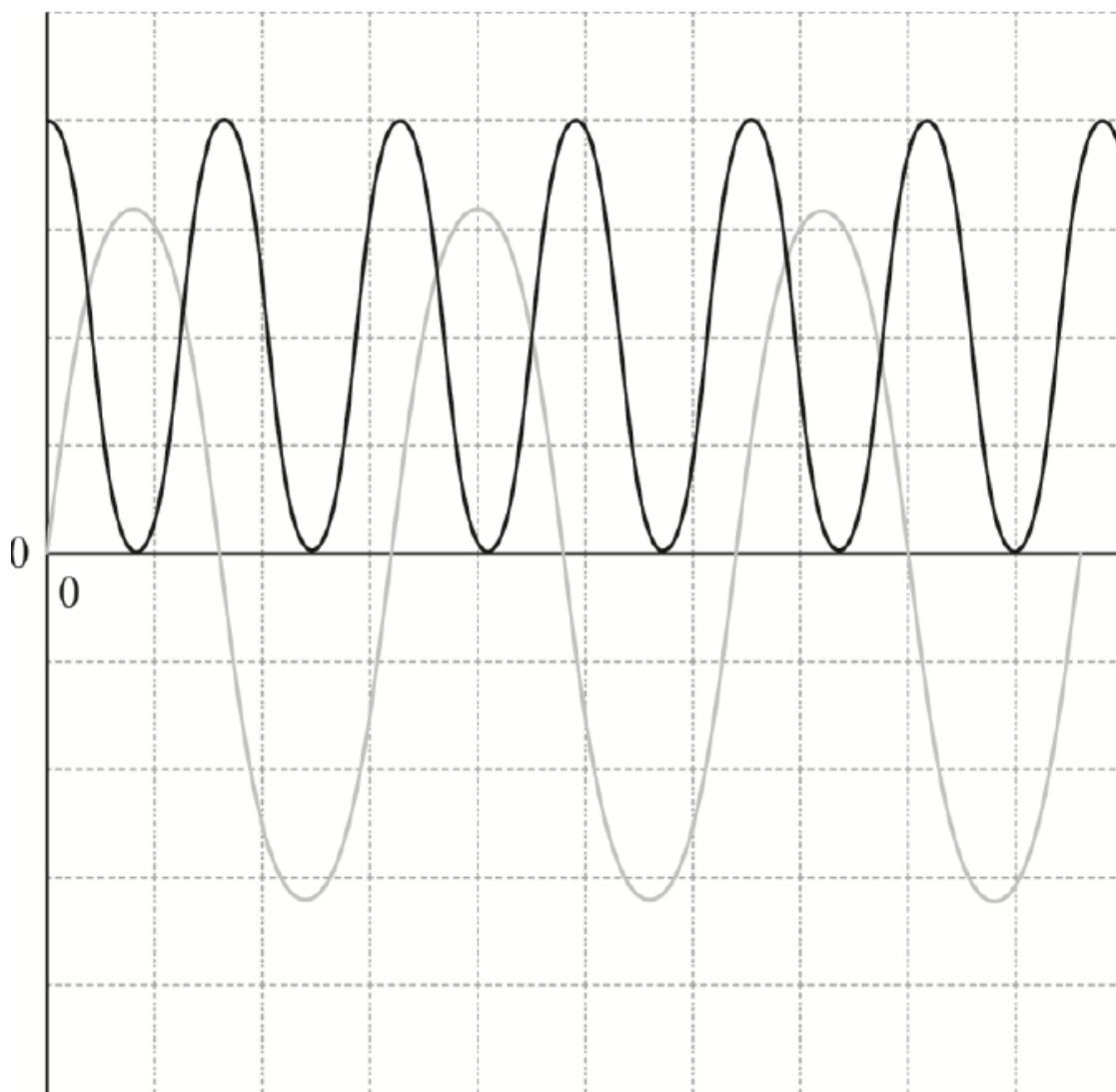

double frequency;

always positive and constant amplitude;

correct phase *ie* cosine squared;

Ignore amplitude value.

A minimum of one complete, original oscillation needed to award [3].

Examiners report

a. (i) Nearly all candidates correctly stated the amplitude as being 32 mm.

(ii) Most were able to measure the period and many then went on to calculate the frequency with the occasional hiccup with conversion of ms into kHz etc.

b. (i) A large proportion of candidates correctly determined the maximum speed of the object by correctly calculating the angular speed and multiplying it by the amplitude. Full marks were awarded to those calculating the gradient of the tangent to the displacement-time graph at zero displacement.

(ii) In the simplest route to the answer candidates were usually successful in measuring the displacement at 140 ms and then using the defining equation for SHM to calculate the acceleration. Other routes were allowed as alternatives but success was infrequent.

- c. Given the relative difficulty of transposing the displacement into a velocity and then squaring it to find the shape of the kinetic energy function, this part was done very well. Most candidates recognised that the energy was always positive, of twice the frequency of the displacement graph and took a cosine squared shape. Sketches were of variable quality but often better than others on the paper.

This question is in **two** parts. **Part 1** is about solar radiation and the greenhouse effect. **Part 2** is about a mass on a spring.

Part 1 Solar radiation and the greenhouse effect

The following data are available.

Quantity	Symbol	Value
Radius of Sun	R	$7.0 \times 10^8 \text{ m}$
Surface temperature of Sun	T	$5.8 \times 10^3 \text{ K}$
Distance from Sun to Earth	d	$1.5 \times 10^{11} \text{ m}$
Stefan-Boltzmann constant	σ	$5.7 \times 10^{-8} \text{ W m}^{-2} \text{ K}^{-4}$

Part 2 A mass on a spring

An object is placed on a frictionless surface and attached to a light horizontal spring.

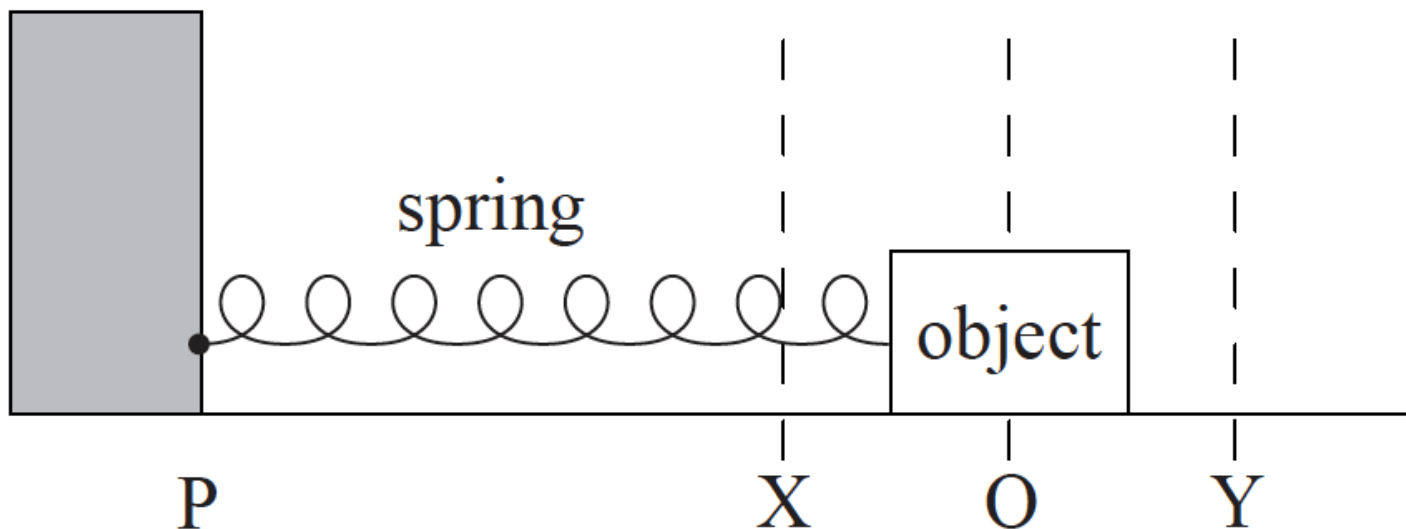

The other end of the spring is attached to a stationary point P. Air resistance is negligible. The equilibrium position is at O. The object is moved to position Y and released.

- a. State the Stefan-Boltzmann law for a black body. [2]
- b. Deduce that the solar power incident per unit area at distance d from the Sun is given by [2]

$$\frac{\sigma R^2 T^4}{d^2}$$

- c. Calculate, using the data given, the solar power incident per unit area at distance d from the Sun. [2]
- d. State **two** reasons why the solar power incident per unit area at a point on the surface of the Earth is likely to be different from your answer in (c). [2]
- e. The average power absorbed per unit area at the Earth's surface is 240Wm^{-2} . By treating the Earth's surface as a black body, show that the average surface temperature of the Earth is approximately 250K. [2]
- f. Explain why the actual surface temperature of the Earth is greater than the value in (e). [3]
- h. Outline the conditions necessary for the object to execute simple harmonic motion. [2]
- i. The sketch graph below shows how the displacement of the object from point O varies with time over three time periods. [4]

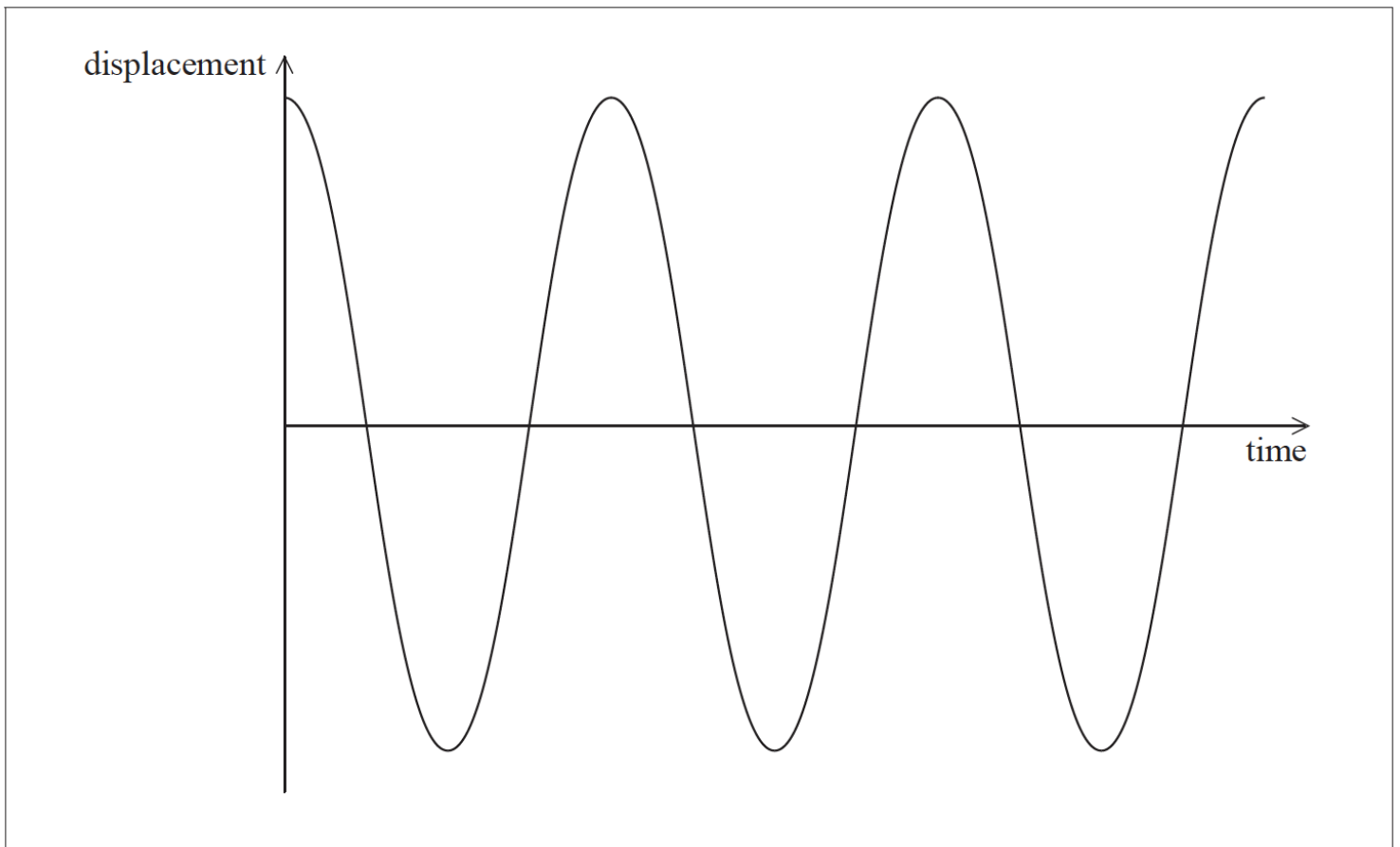

- (i) Label with the letter A a point at which the magnitude of the acceleration of the object is a maximum.
- (ii) Label with the letter V a point at which the speed of the object is a maximum.
- (iii) Sketch on the same axes a graph of how the displacement varies with time if a **small** frictional force acts on the object.
- j. Point P now begins to move from side to side with a small amplitude and at a variable driving frequency f . The frictional force is still small. [4]
- At each value of f , the object eventually reaches a constant amplitude A .
- The graph shows the variation with f of A .

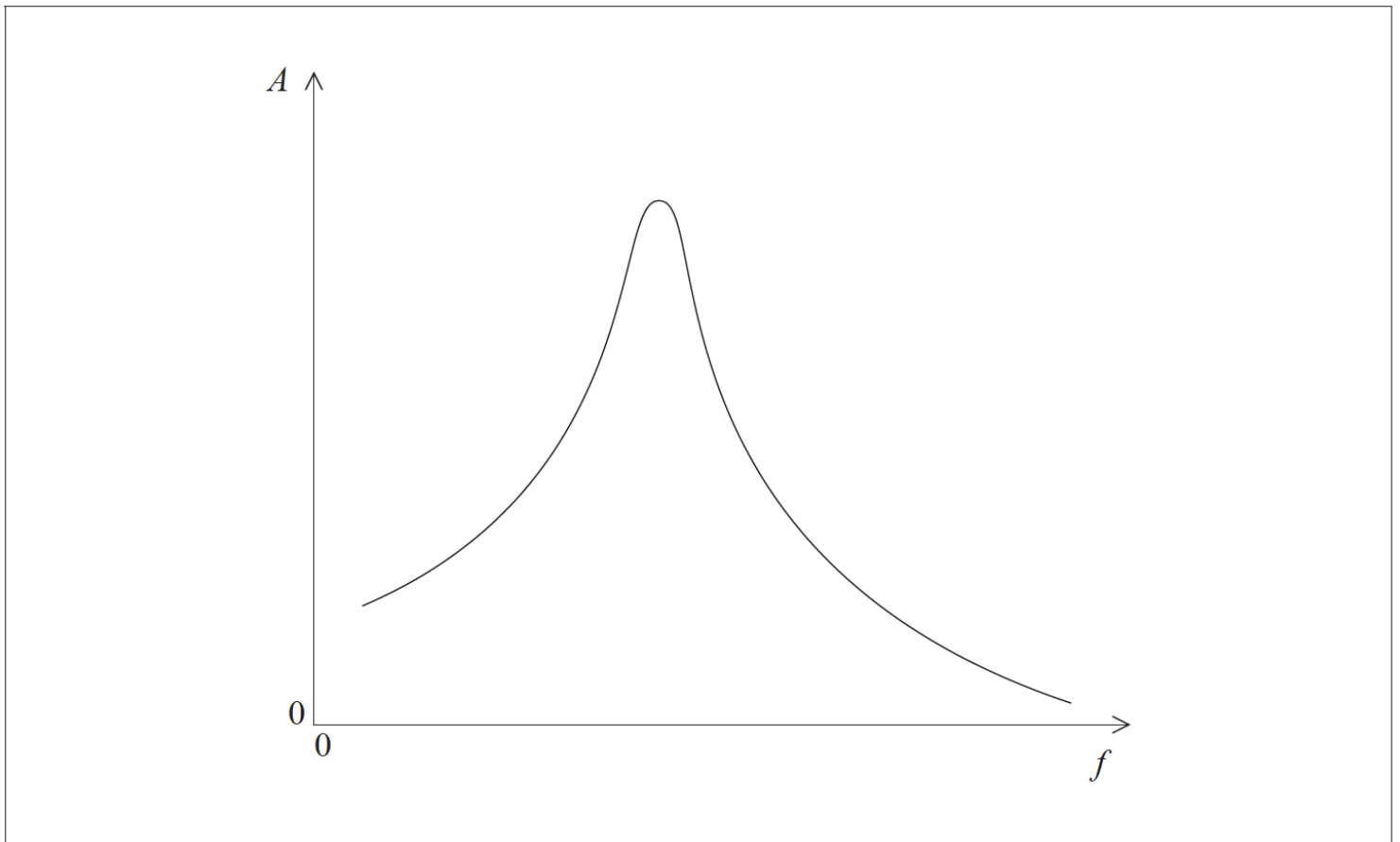

(i) With reference to resonance and resonant frequency, comment on the shape of the graph.

(ii) On the same axes, draw a graph to show the variation with f of A when the frictional force acting on the object is increased.

Markscheme

a. power/energy per second emitted proportional to surface area;

and proportional to fourth power of absolute temperature / temperature in K;

Accept equation with symbols defined.

b. solar power given by $4\pi R^2\sigma T^4$;

spreads out over sphere of surface area $4\pi d^2$;

Hence equation given.

$$c. \left(\frac{\sigma R^2 T^4}{d^2} \right) = \frac{5.7 \times 10^{-8} \times [7.0 \times 10^8]^2 \times [5.8 \times 10^3]^4}{[1.5 \times 10^{11}]^2};$$

$$= 1.4 \times 10^3 (\text{Wm}^{-2});$$

Award [2] for a bald correct answer.

d. some energy reflected;

some energy absorbed/scattered by atmosphere; depends on latitude;

depends on time of day;

depends on time of year;

depends on weather (eg cloud cover) at location; power output of Sun varies;

Earth-Sun distance varies;

e. power radiated = power absorbed;

$$T = \sqrt[4]{\frac{240}{5.7 \times 10^{-8}}} = (250\text{K});$$

Accept answers given as 260 (K).

f. radiation from Sun is re-emitted from Earth at longer wavelengths; greenhouse gases in the atmosphere absorb some of this energy; and radiate some of it back to the surface of the Earth;

h. the force (of the spring on the object)/acceleration (of the object/point O) must be proportional to the displacement (from the equilibrium position/centre/point O);

and in the opposite direction to the displacement / always directed towards the equilibrium position/centre/point O;

i. (i) one A correctly shown;

(ii) one V correctly shown;

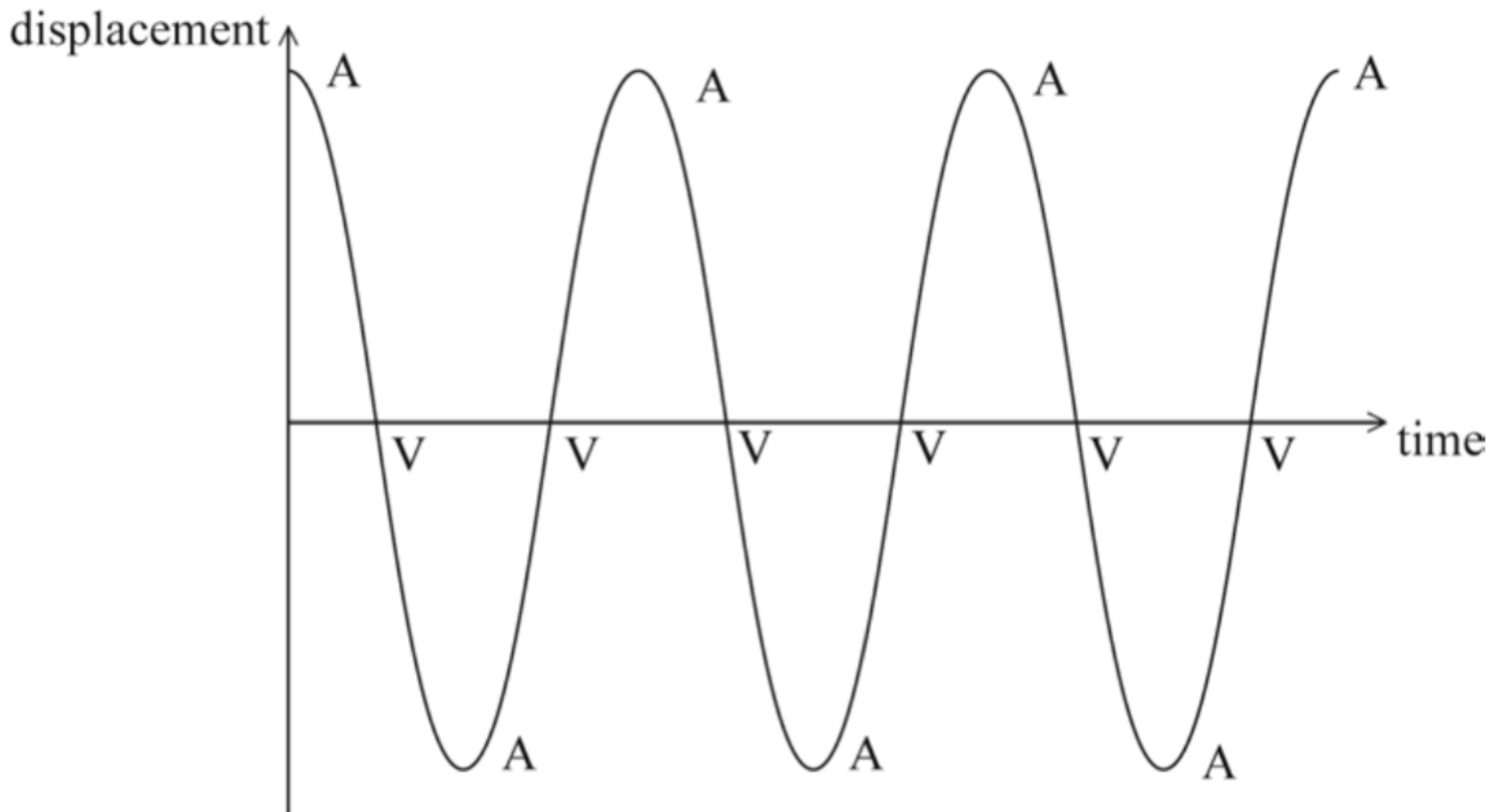

(iii) same period; (judge by eye)

amplitude decreasing with time;

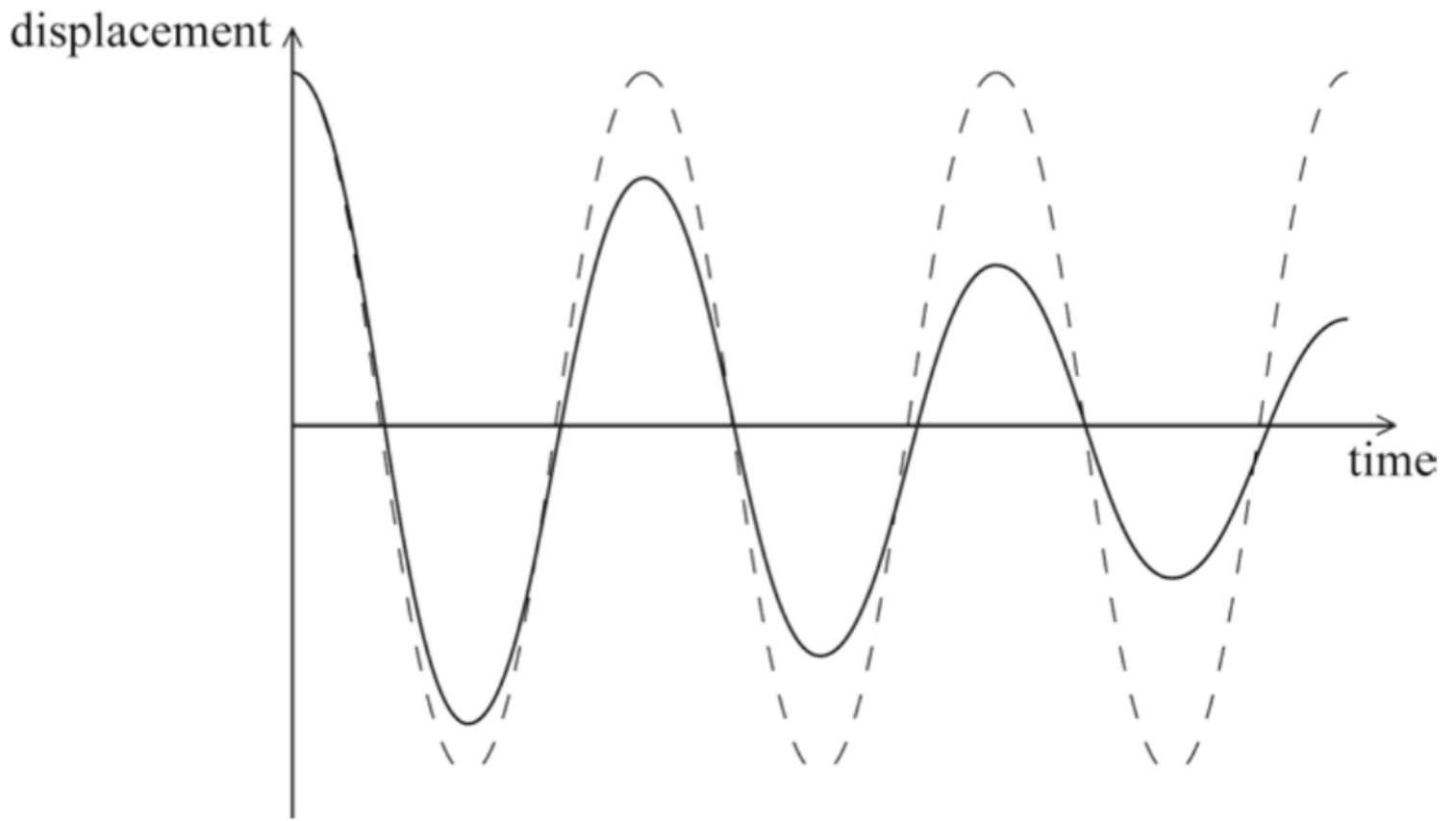

j. (i) resonance is where driving frequency equals/is close to natural/resonant frequency;

the natural/resonant frequency is at/near the maximum amplitude of the graph;

(ii) lower amplitude everywhere on graph, bit still positive;

maximum in same place/moved slightly (*that is, between the lines*) to left on graph;

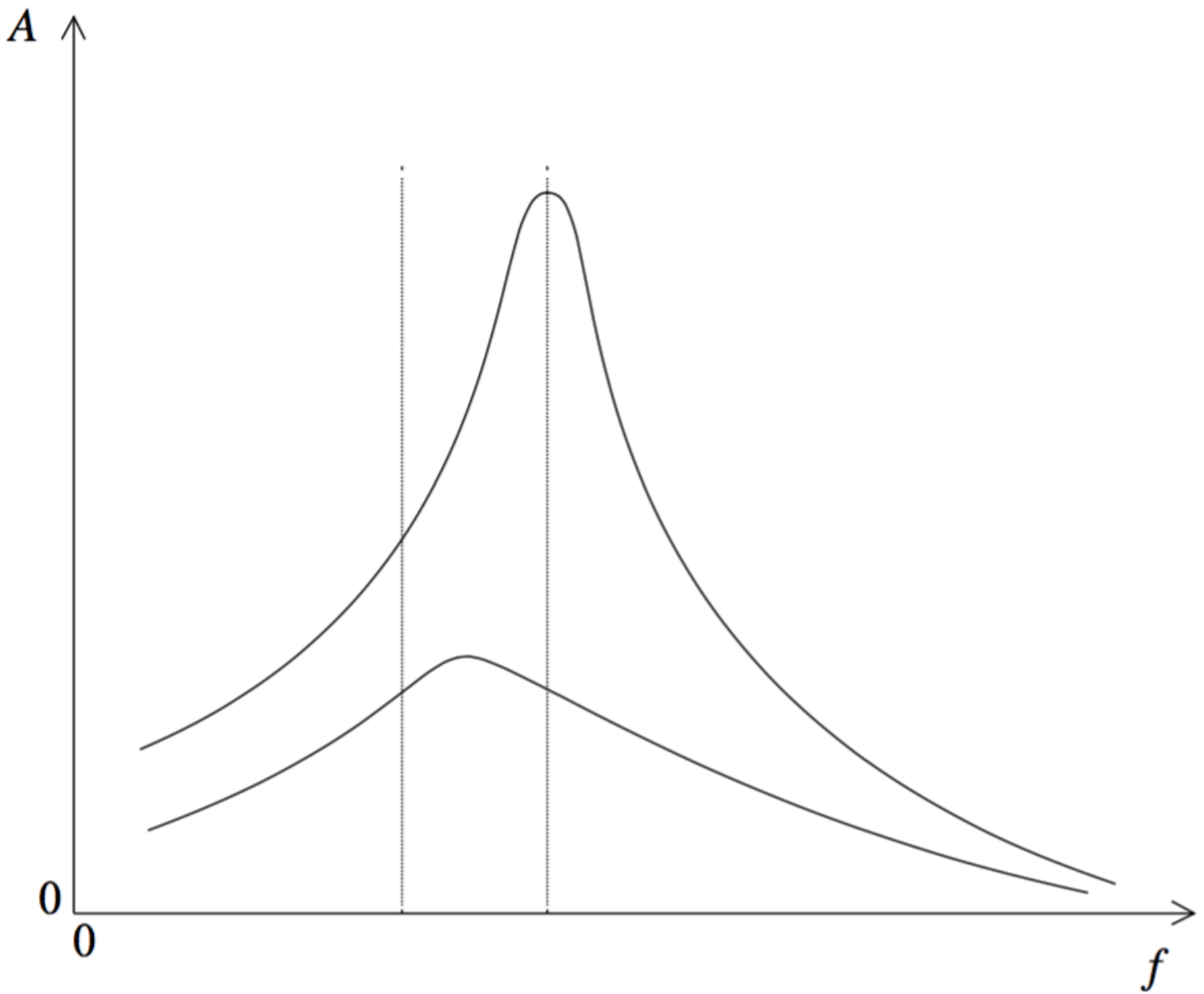

Examiners report

- The Stefan-Boltzmann law was poorly understood with few candidates stating that the absolute temperature is raised to the fourth power.
- This question was poorly done with few candidates substituting the surface area of the sun or the surface area of a sphere at the Earth's radius of orbit.
- Despite not being able to state or manipulate the Stefan-Boltzmann law most candidates could substitute values into the expression and calculate a result.
- This question was well answered at higher level.
- To show the given value there is the requirement for an explanation of why the incident power absorbed by the Earth's surface is equal to the power radiated by the Earth, few candidates were successful in this aspect. Although most could substitute into the Stefan-Boltzmann equation they needed to either show that the fourth root was used or to find the temperature to more significant figures than the value given.
- A surprising number of candidates could not explain the greenhouse effect. A common misunderstanding was that the Earth reflected radiation into the atmosphere and that the atmosphere reflected the radiation back to the Earth.

- h. The conditions for simple harmonic motion were poorly outlined by most candidates. Few identified a relationship between force/acceleration and displacement, with most talking about it going backwards and forwards without slowing down.
- i. This question was well answered by many. The only notable mistake was with reducing the time period of the damped oscillation.
- j. i) Identifying the peak of the graph with the resonant frequency was broadly successfully done but not many candidates stated that this occurs when the driving frequency is equal to the natural frequency.
ii) This sketch was generally well done.

This question is in **two** parts. **Part 1** is about the greenhouse effect. **Part 2** is about an electric motor.

Part 1 Greenhouse effect

- a. Describe what is meant by the greenhouse effect in the Earth's atmosphere. [3]
- b. The graph shows the variation with frequency of the percentage transmittance of electromagnetic waves through water vapour in the atmosphere. [9]

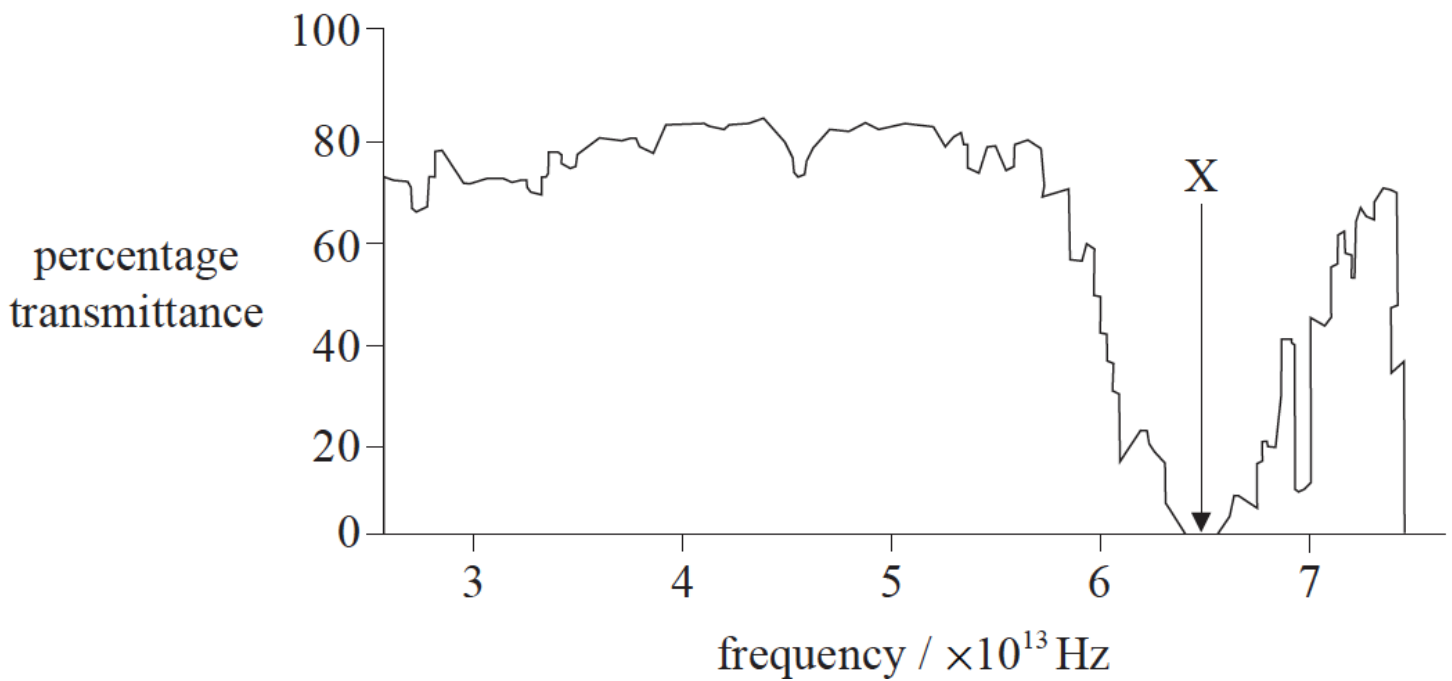

- (i) Show that the reduction in percentage transmittance labelled X occurs at a wavelength equal to approximately 5 μm .
- (ii) Suggest, with reference to resonance, the possible reasons for the sharp reduction in percentage transmittance at a wavelength of 5 μm .
- (iii) Explain how the reduction in percentage transmittance, labelled X on the graph opposite, accounts for the greenhouse effect.
- (iv) Outline how an increase in the concentration of greenhouse gases in the atmosphere may lead to global warming.

Markscheme

a. effect caused by gas such as $H_2O/NH_3/CH_4/CO_2$ /greenhouse gas in the atmosphere;

gas absorbs outgoing (long wave) radiation from Earth;

gas re-radiates some of the energy back to Earth;

b. (i) $\frac{3.0 \times 10^8}{6.5 \times 10^{13}} = 4.6 (\mu m)$;

$\approx 5(\mu m)$

(ii) water vapour molecules have a natural frequency of oscillation;

if this frequency of oscillation is 6.5×10^{13} / reference to frequency at X;

due to resonance this radiation is readily absorbed by the molecules / the radiation matches the natural frequency of oscillation;

or

X is a natural frequency (of oscillation) of water molecule;

so resonance effects mean that molecules are excited at this frequency;

and energy is removed/less energy transmitted from electromagnetic waves at this (particular) frequency;

(iii) energy gained by absorption needs to be re-emitted (as molecules de-excite);

in other directions / some returns to Earth;

(iv) more greenhouse gases means that there is more absorption of outgoing radiation;

therefore more energy returns to Earth;

leading to a further/greater increase in the temperature of the surface (of Earth);

Examiners report

a. [N/A]

b. [N/A]

This question is in two parts. Part 1 is about a thermistor circuit. Part 2 is about vibrations and waves.

Part 1 Thermistor circuit

The circuit shows a negative temperature coefficient (NTC) thermistor X and a $100\text{ k}\Omega$ fixed resistor R connected across a battery.

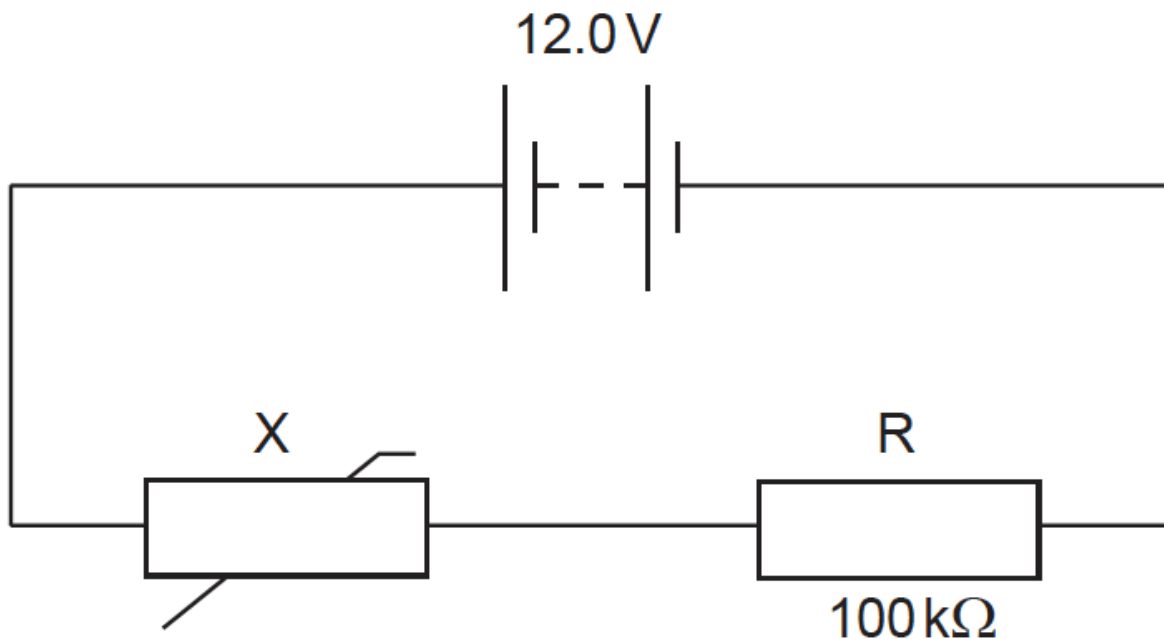

The battery has an electromotive force (emf) of 12.0 V and negligible internal resistance.

Part 2 Vibrations and waves

The cone and dust cap D of a loudspeaker L vibrates with a frequency of 1.25 kHz with simple harmonic motion (SHM).

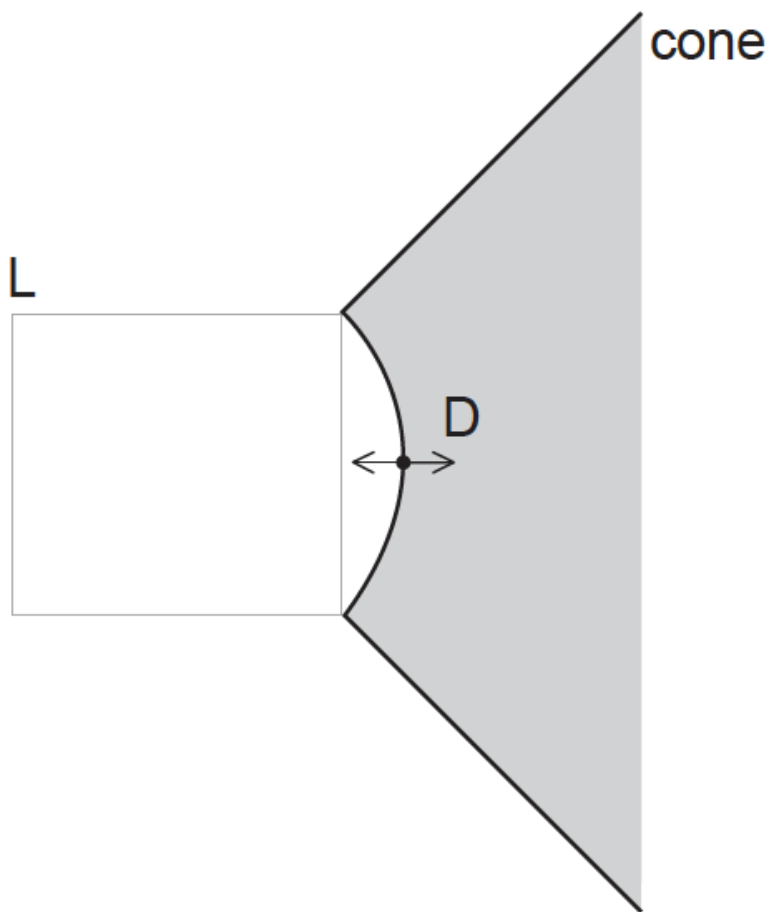

a. (i) Define *electromotive force (emf)*. [2]

(ii) State how the emf of the battery can be measured.

b. The graph below shows the variation with temperature T of the resistance R_x of the thermistor. [7]

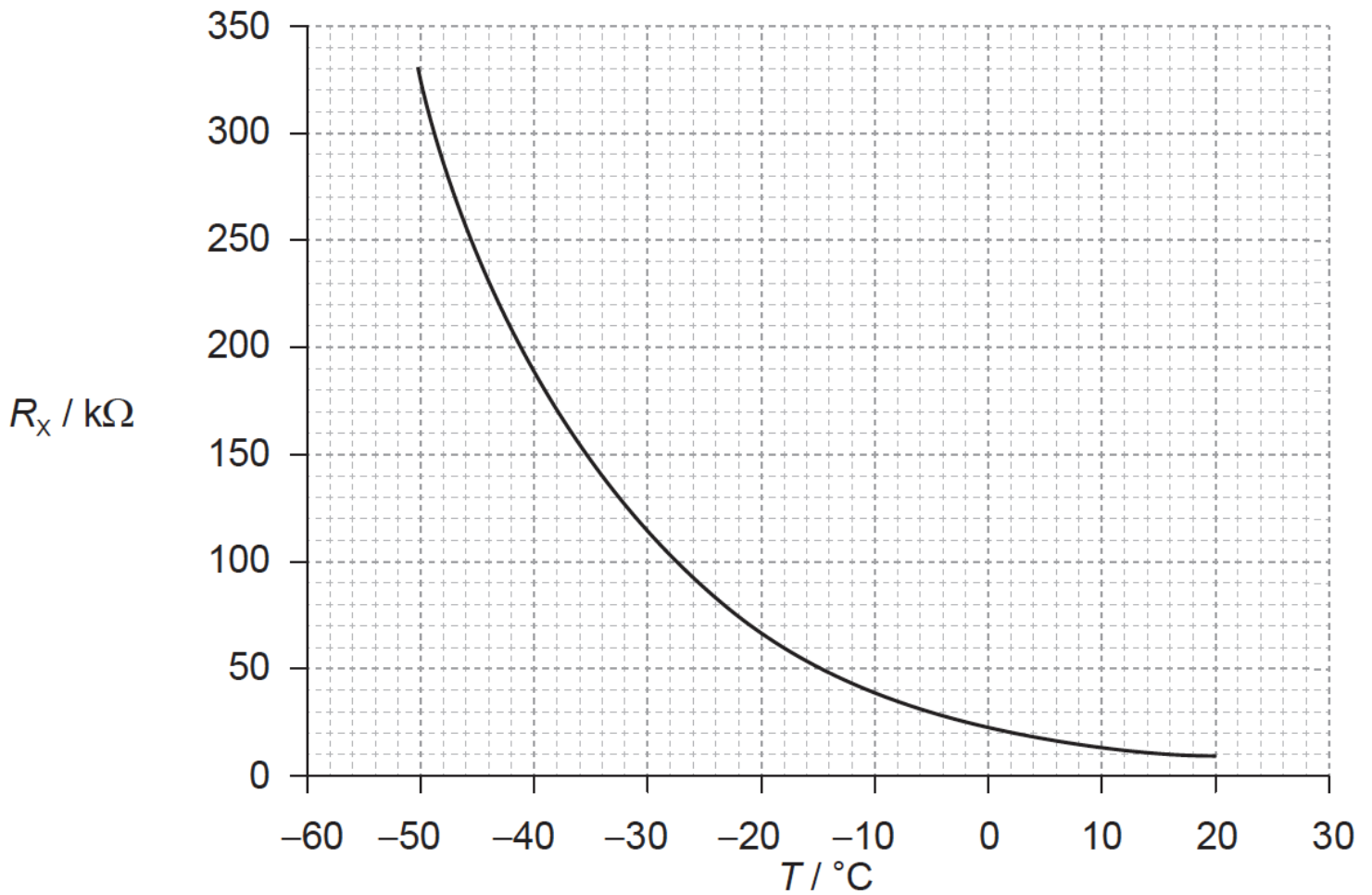

- (i) Determine the temperature of X when the potential difference across R is 4.5V.
- (ii) State the range of temperatures for which the change in the resistance of the thermistor is most sensitive to changes in temperature.
- (iii) State and explain the effect of a decrease in temperature on the ratio

$$\frac{\text{voltage across X}}{\text{voltage across R}}$$

- c. Define *simple harmonic motion (SHM)*. [2]
- d. D has mass 6.5×10^{-3} kg and vibrates with amplitude 0.85 mm. [4]
 - (i) Calculate the maximum acceleration of D.
 - (ii) Determine the total energy of D.
- e. The sound waves from the loudspeaker travel in air with speed 330 ms^{-1} . [2]
 - (i) Calculate the wavelength of the sound waves.
 - (ii) Describe the characteristics of sound waves in air.
- f. A second loudspeaker S emits the same frequency as L but vibrates out of phase with L. The graph below shows the variation with time t of the displacement x of the waves emitted by S and L. [6]

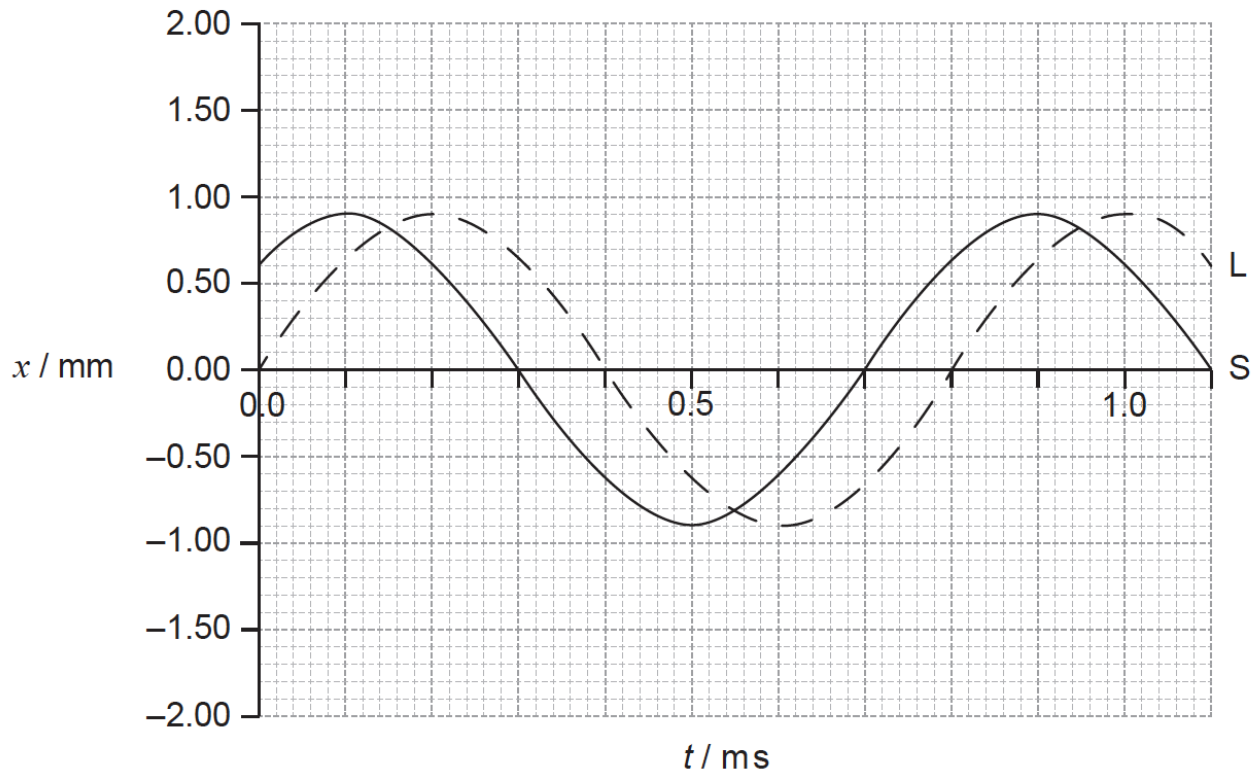

(i) Deduce the relationship between the phase of L and the phase of S.

(ii) On the graph, sketch the variation with t of x for the wave formed by the superposition of the two waves.

Markscheme

a. (i) the work done per unit charge in moving a quantity of charge completely around a circuit / the power delivered per unit current / work done per unit charge made available by a source;

(ii) place voltmeter across battery;

b. (i) $V_X = 7.5 \text{ V}$;

$$I \left(= \frac{4.5}{100 \times 10^3} \right) = 4.5 \times 10^{-5} \text{ A or } \frac{V_X}{V_R} = \frac{R_x}{R_R};$$

$$R_x \left(= \frac{7.5}{4.5 \times 10^{-5}} \right) = 1.67 \times 10^5 \Omega \text{ or } R_x \left(= \frac{7.5}{4.5} \times 100 \times 10^3 \right) = 1.67 \times 10^5 \Omega;$$

$$T = -37 \text{ or } -38^\circ\text{C}$$

(ii) -50 to (up to) -30°C / at low temperatures;

(iii) as the temperature decreases R_x increases;

same current through R and X so the ratio increases **or** V_X increases and V_R decreases so the ratio increases;

c. (periodic) motion in which acceleration/restoring force is proportional to the displacement from a fixed point;

directed towards the fixed point / in the opposite direction to the displacement;

d. (i) $\omega = (2\pi f = 2\pi \times 1250) 7854 \text{ rad s}^{-1}$;

$a_0 = (-\omega^2 x_0 = -7854^2 \times 0.85 \times 10^{-3} =) (-) 5.2 \times 10^4 \text{ ms}^{-2}$;

(ii) correct substitution into $E_T = \frac{1}{2} m \omega^2 x_0^2$ irrespective of powers of 10;

0.14 to 0.15 J;

e. (i) 0.264 m;

(ii) longitudinal;

progressive / propagate (through the air) / travels with constant speed (through the air);

series of compressions and rarefactions / high and low (air) pressure;

f. (i) S leads L / idea that the phase of L is the phase of S minus an angle;

$\frac{1}{8}$ period / $1 \times 10^{-4} \text{ s}$ / 0.1 ms;

$\frac{\pi}{4}$ / 0.79 rad / 45 degrees;

(ii) agreement at all zero displacements;

maxima and minimum at correct times;

constant amplitude of 1.60 mm;

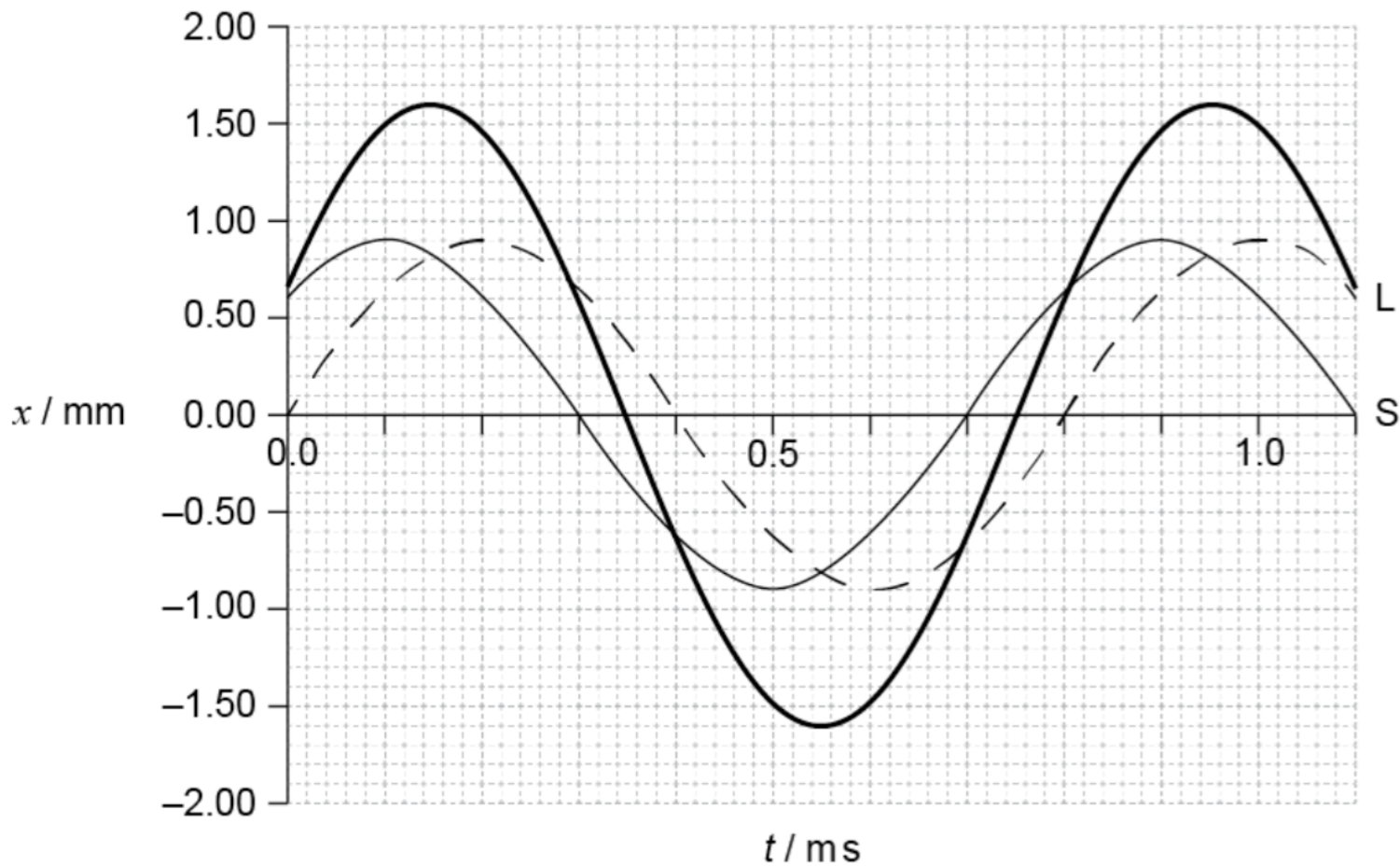

- a. [N/A]
 - b. [N/A]
 - c. [N/A]
 - d. [N/A]
 - e. [N/A]
 - f. [N/A]
-